

LA BOUGIE D 'ALLUMAGE ***NGK***



- **Modification des conditions de roulage :**
 - Petits trajets
 - Embouteillages

- **Modification des conditions d'utilisation :**
 - Essence sans Plomb
 - Normes anti-pollution

- **Modification des Moteurs**
 - Meilleure gestion des polluants



- **Modification des Risques :**
 - Dommages sur le Catalyseur
 - Refus au Contrôle Technique
- **Espacement des Révisions**
- **Accès difficile aux Bougies**

Les Conséquences Techniques

- Évolution des technologies :

1950



1980



2000



BOUGIE ⇒ PRODUIT TECHNIQUE



- Elle renforce le rôle technique des professionnels.
- Elle a une durée de vie en augmentation, MAIS :
 - Il s'agit de tests réalisés sur banc.
 - Il est impératif de vérifier les bougies lors de chaque révision majeure.
 - Il faut remplacer les bougies si nécessaire (usure, encrassement) et dans tous les cas recommandé au plus tard entre 75 à 95% de la préconisation.

MOTEUR	Remplacement Conseillé des Bougies (km) sauf préconisation différente du constructeur		
	Mono-électrode	Multi-électrode	Metaux précieux
Allumage Rupteurs	7 000 → 12 000		
Allumage Électronique	10 000 → 20 000	20 000 → 30 000	20 000 → 40 000
Injection et Catalyseur	20 000 → 30 000	30 000 → 60 000	40 000 → 100 000

Qu'est ce que l'indice thermique et comment le maîtrise-t-on ?



- L 'indice thermique correspond à la capacité qu 'a une bougie à absorber et à évacuer la chaleur émise par l 'inflammation du mélange Air / Essence, tout en restant dans sa plage d 'utilisation optimale, soit entre 450° C et 870° C.

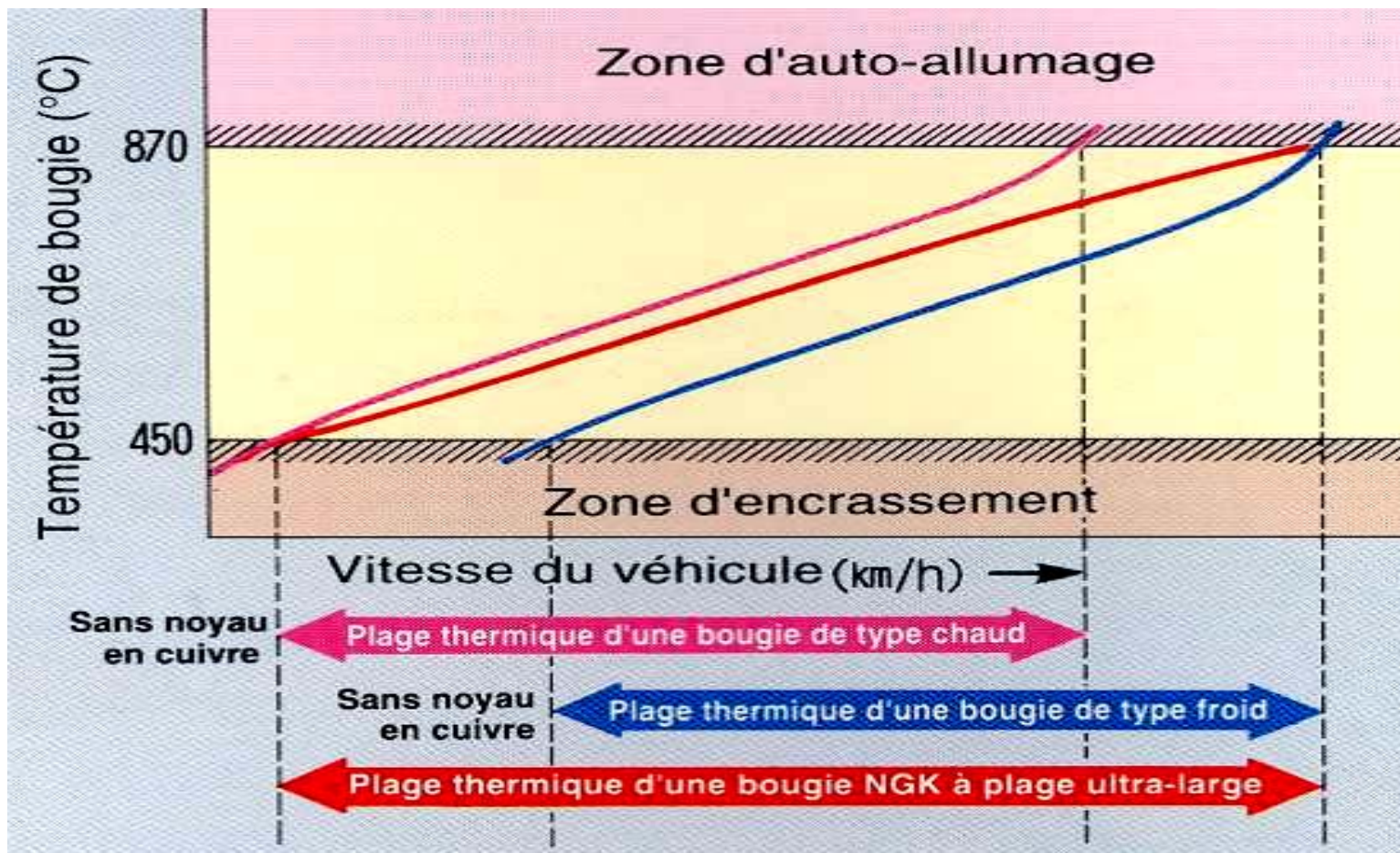



- On maîtrise l'indice thermique d'une bougie en faisant varier :
 - La surface de contact entre la céramique et la zone d'inflammation pour l'absorption de la chaleur.
 - La surface de contact entre la céramique et le culot pour l'évacuation de la chaleur.

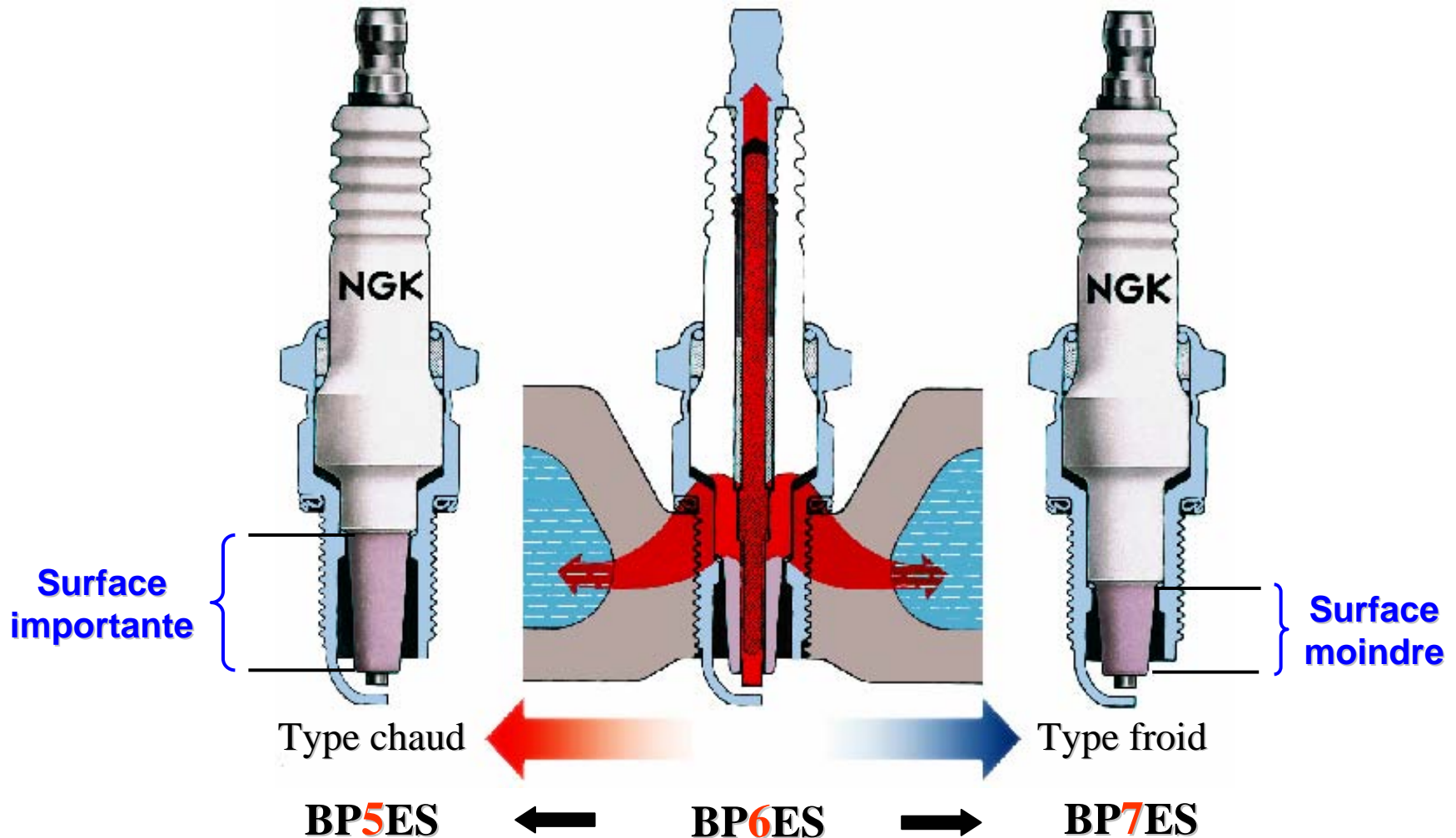

Les Bougies NGK

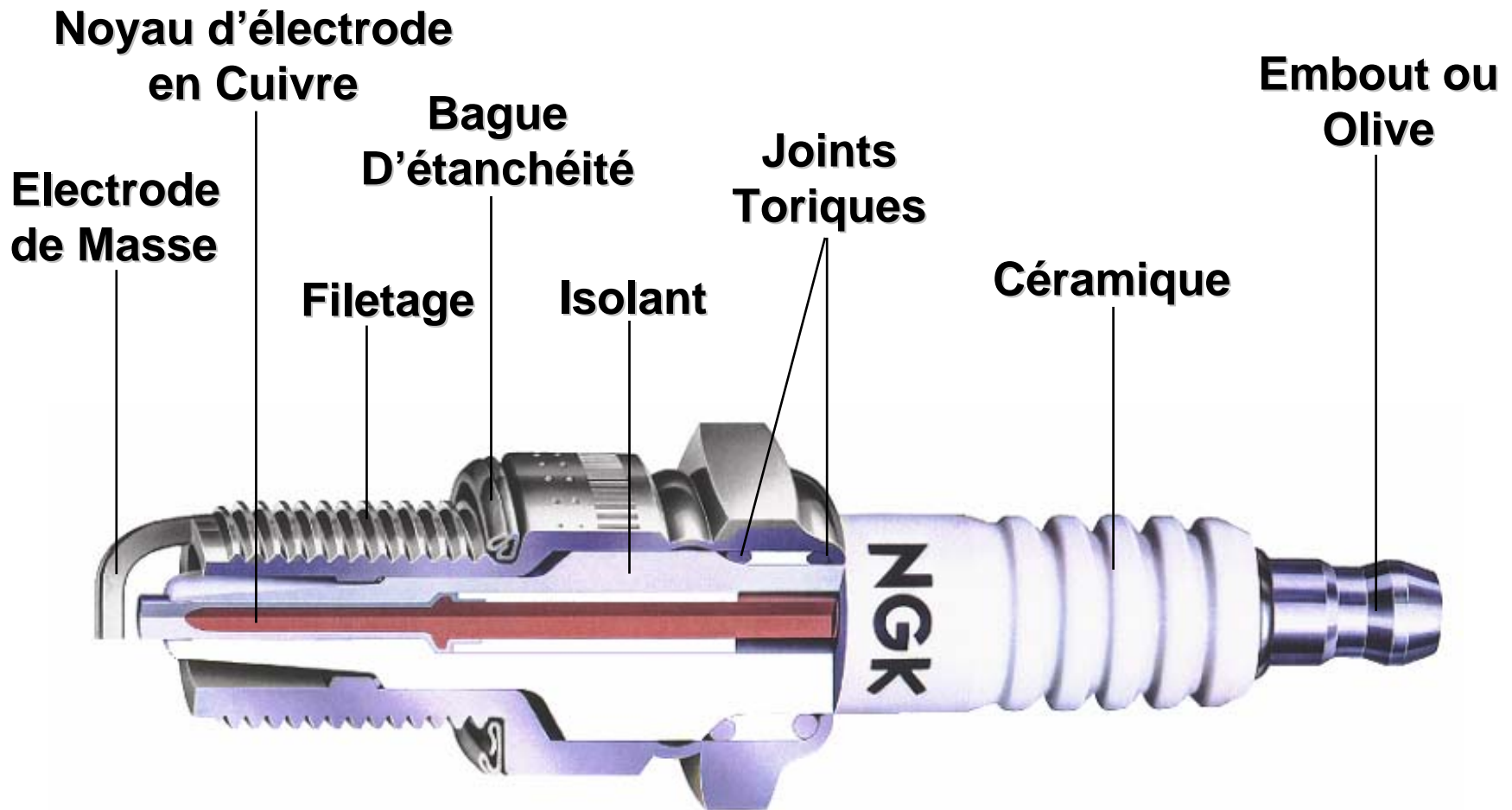

Résistance en Céramique

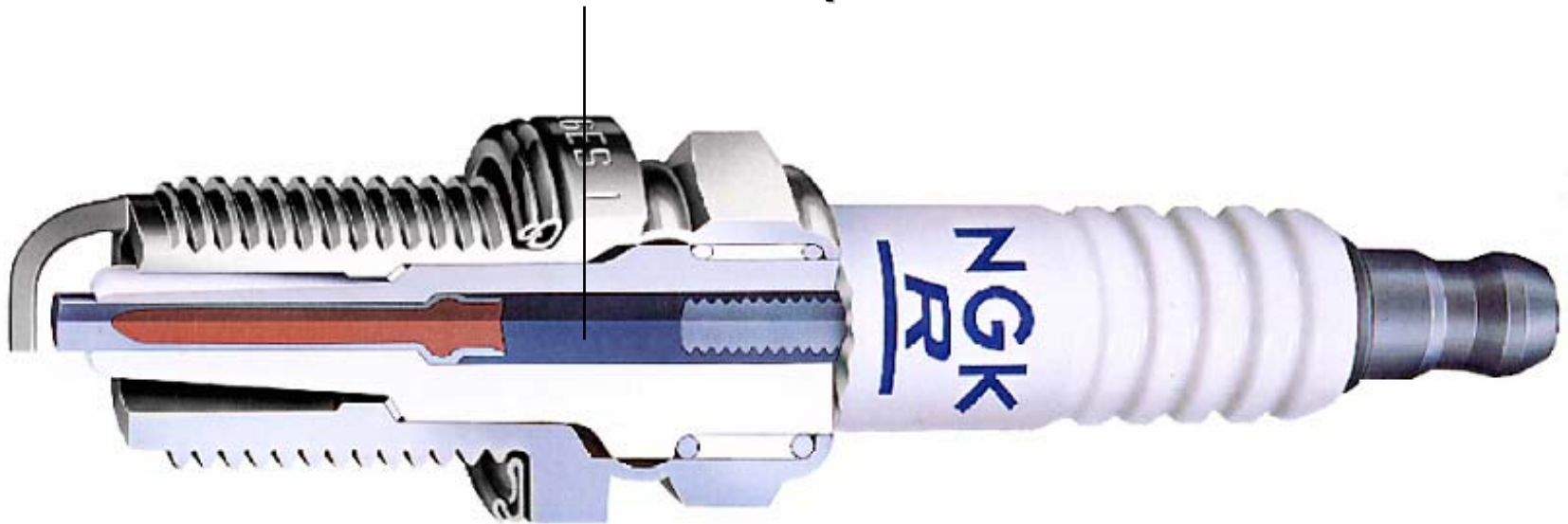

- Pourquoi ?

- Pour diminuer les Parasites



- Protection de l'électronique embarquée (Calculateur d'ABS et d'Injection, la téléphonie mobile, la radio, l'environnement, ...)

- Comment ?



- Par un ciment résistif de 5 k Ω



- Poudre céramique vitrifiée indestructible et profondément insérée.

- Elles possèdent les mêmes caractéristiques que les bougies non résistives sur :
 - L 'efficacité au démarrage, à l 'accélération.
 - La consommation
 - L 'encrassement
- Actuellement montées d 'origine sur quasiment tous les types de véhicules
- Dans le doute (pot catalytique) une bougie résistive ne peut pas faire de mal,
Le contraire, Si.

Description des Références d'une bougie NGK

B	P	5	E	S	-11
Diamètre de filetage	Configuration et caractéristiques	Degré thermique	Longueur de filetage	Configuration et caractéristiques	Ecartement des électrodes
A 18mm B 14mm C 10mm D 12mm E 8mm BC 14mm (Diamètre de section hexagonale 16 mm)	P Type à bec d'isolant proéminent R Type à résistance incorporée U Type à décharge superficielle ou semi-superficielle	2 Type chaud 4 5  6 7 8 9 10 11 12  13 Type froid	E 19,0mm H 12,7mm	S Type standard Y Type à électrode centrale à gorge en V V Type à électrode centrale constituée de métaux précieux VX Type VX K Type à deux électrodes de masse M Type à deux électrodes de masse (pour moteurs rotatifs) Q Type à quatre électrodes de masse (pour moteurs rotatifs) B Type pour moteurs CVCC J Type à deux électrodes de masse obliques A Type spécial C Type à électrode de masse oblique	9 0,9mm 10 1,0mm 11 1,1mm 13 1,3mm ----- -L ... Degré thermique intermédiaire -N ... Electrode de masse de dimensions spéciales
BK Type BCP classé suivant les normes ISO. La longueur comprise entre le siège de joint et l'embout terminal de la bougie aux normes est cependant inférieure de 2,5 mm par rapport à celle du type BCP.					

P	F	R	5	A	-11
<p>P: Type en platine Z: Type proéminent</p>	<p>(Diamètre et longueur de filetage et diamètre de section hexagonale) F: $\phi 14 \times 19 \text{mm}$ Section hexagonale 16mm G: $\phi 14 \times 19 \text{mm}$ Section hexagonale 20,6mm J: $\phi 12 \times 19 \text{mm}$ Section hexagonale 18mm L: $\phi 10 \times 12,7 \text{mm}$ Section hexagonale 16mm</p>	<p>R: Type à résistance incorporée</p>	<p>Degré thermique 5 Type chaud 6 7 Type froid</p> 	<p>A, B, C, ... Autres sigles</p>	<p>Ecartement des électrodes -11: 1,1 mm</p>

La Gamme NGK

Standard



10 - 20 000 Km

**2 Electrodes
de Masse**



20 - 40 000 Km

**3 Electrodes
de Masse**



30 - 60 000 Km

**4 Electrodes
de Masse**



40 - 80 000 Km

A CHAQUE MOTEUR, SA TECHNOLOGIE



**Mono
électrode**



**Double
électrode**



**Triple
électrode**



**Quadruple
électrode**



**Electrode de
masse projetée**

Ex : BE529Y-11



Filetage : 12mm

Héxagone : 16mm

Ex : DCPR6E



Type compact

Ex : BPMR7A



Filetage : 14mm

Héxagone : 21mm

Ex : BPR6ES



Filetage : 10mm

Héxagone : 16mm

Ex : CR8E



Filetage : 8mm

Héxagone : 13mm

Ex : ER9EH

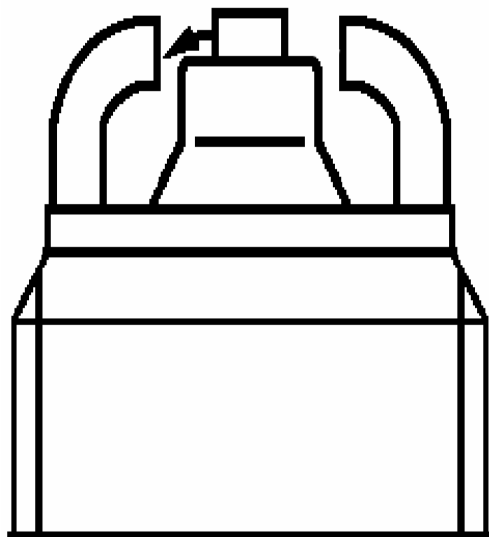

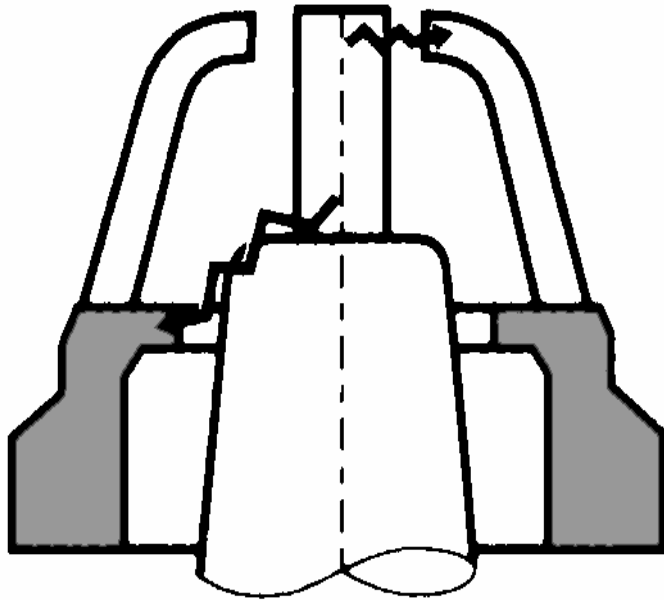

- **Bougie avec Gorge en « V » :**

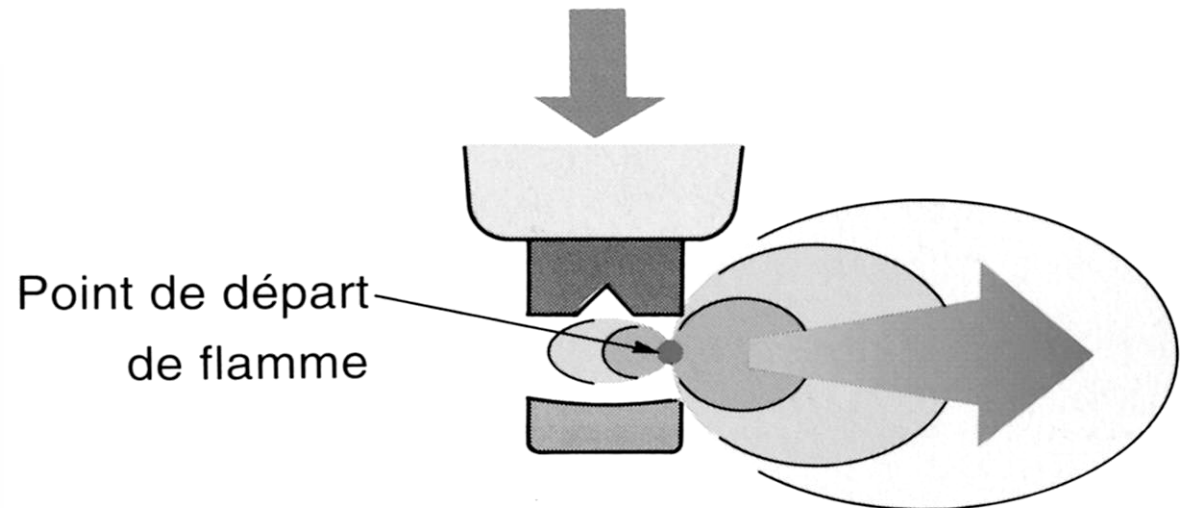

(La flamme se trouve générée à la périphérie de l'électrode centrale et se propage amplement vers l'extérieur.)

➤ Ex: BKR6ES --> BKR6E

La Gamme NGK

- La bougie **VX** :

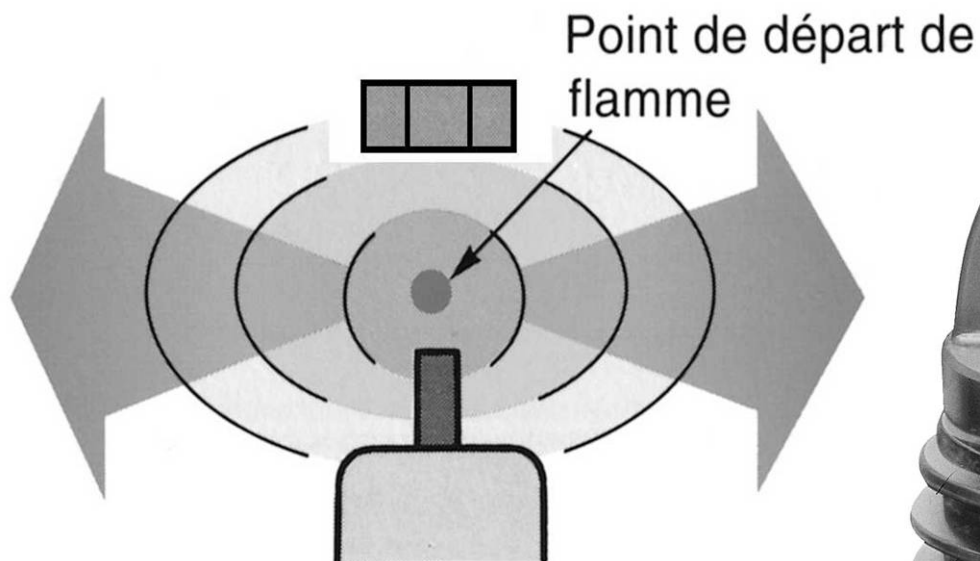

➤ Ex: BKR5ES --> BKR5EVX

- **La bougie Double Platine :**



➤ Ex: PLFR5A-11
d'origine sur Renault Velsatis

- **La bougie Iridium :**



- Ex: IFR6D-10
d'origine sur Mercedes-Benz

- **La bougie Iridium IX :**



- **Ex: BKR6EIX**

IRIDIUM IX

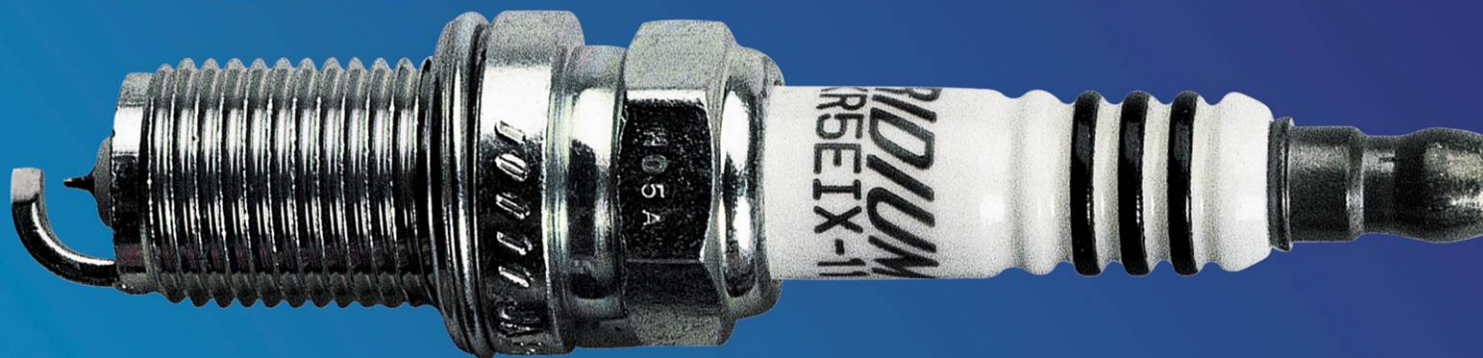

- **La technologie anti-encrassement :**

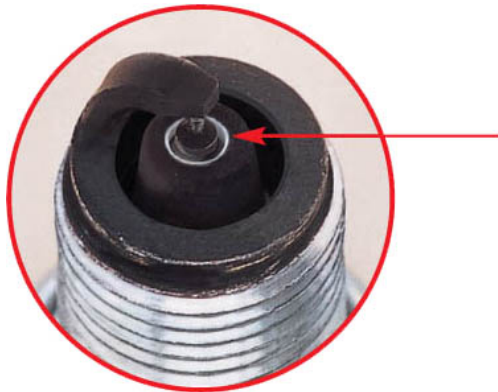

La technologie “2 Steps” (escaliers) évite l’encrassement de l’isolant améliorant ainsi la qualité de l’allumage et la protection du pot catalytique.

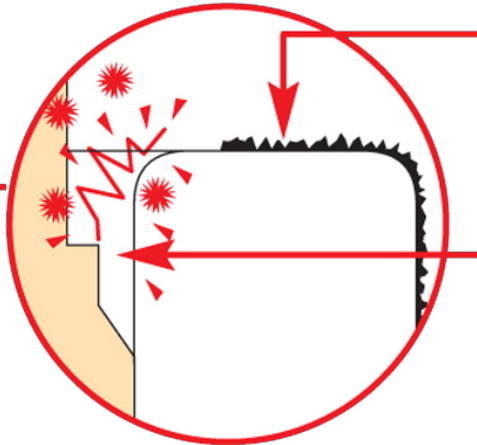
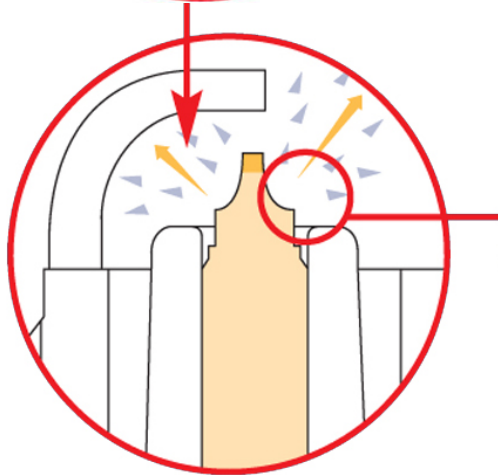

Dépôt de carbone

L’arc électrique fait éclater les dépôts de carbone

- **La bougie Racing :**



- Une solution pour chaque utilisateur :



Origine

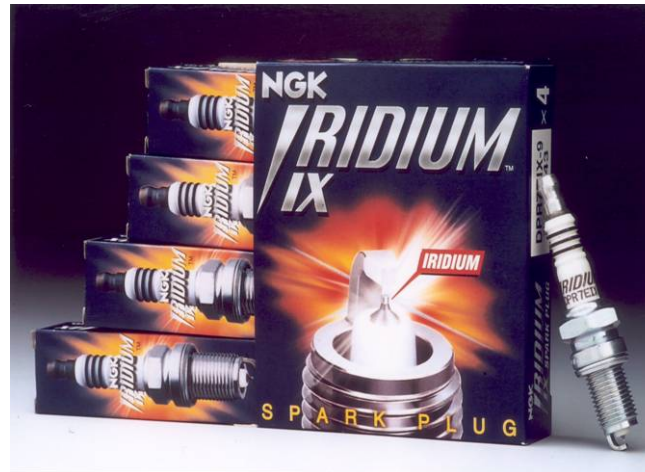

Tuning



Racing

- **La Règle N°1 :**

- Respecter la préconisation constructeur.
Cela correspond à la référence que vous trouvez dans le catalogue NGK.

Ensuite, suivant les utilisations du véhicule, il est possible de changer de technologie de bougie ou d'indice thermique.



EVITER LES CORRESPONDANCES

Rappel de quelques Règles



1. Utiliser une clé à bougie adaptée.
2. Effectuer le changement sur un moteur froid.
3. Tourner légèrement le capuchon pour le décoller et l'enlever sans tirer sur le câble.
4. Desserrer de 1/4 de tour la bougie puis souffler les saletés et poussières à l'air comprimé ou au pinceau.
5. Démonter la bougie puis nettoyer son siège avant d'en remonter une neuve, sans graisse sur le filet, en la vissant à la main jusqu'au contact avec la culasse.
6. Serrer la bougie à la clé dynamométrique au couple préconisé.

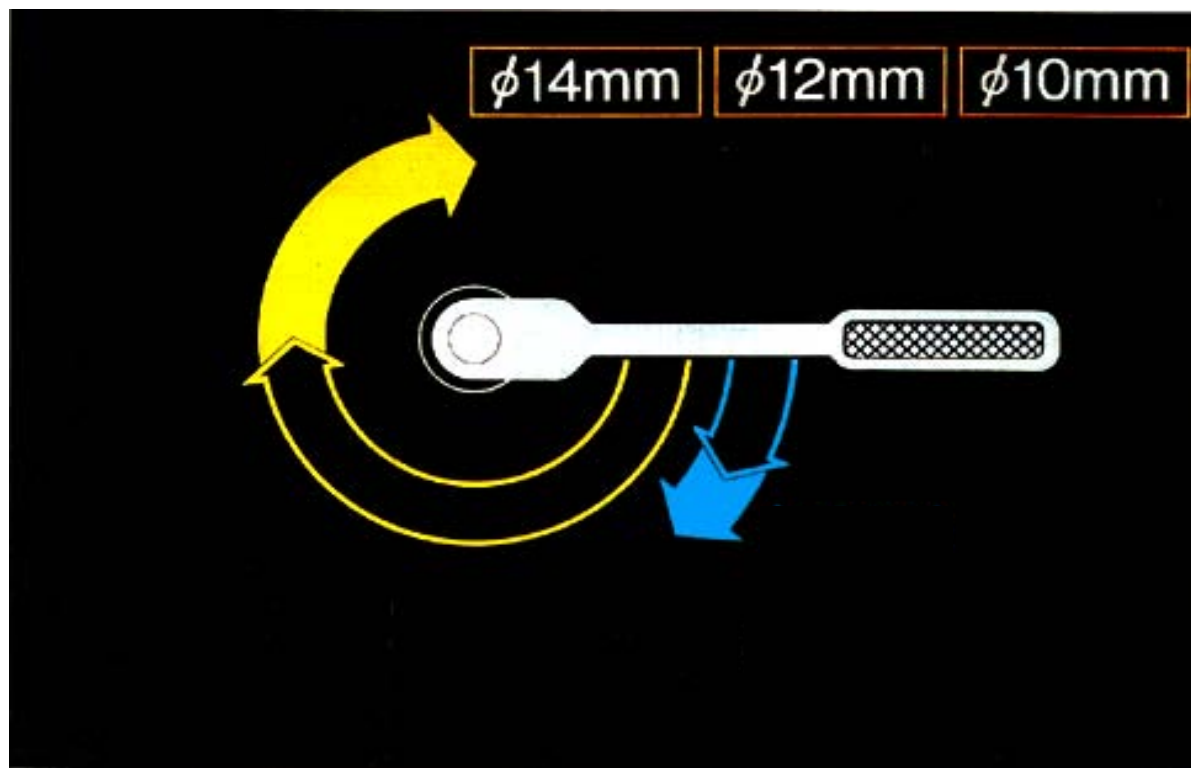

14 mm: 25-30 Nm

12 mm: 15-20 Nm

10 mm: 10-12 Nm

Interprétation de l'aspect des bougies



Changement de couleur du bec d'isolant et présence de mini résidus de combustion, le moteur est en bon état de fonctionnement.



Le plomb contenu dans l'essence se dépose sur la partie allumage pouvant provoquer des ratés d'allumage.



L'usure importante des électrodes peut provoquer des ratés d'allumage et un mauvais comportement du moteur au démarrage.



Les électrodes et le bec d'isolant sont recouverts de suie grasse d'huile ou de calamine pouvant provoquer des démarrages difficiles et des ratés d'allumage.



Dépôts liés à l'usure mécanique du moteur pouvant provoquer de l'Auto Allumage.



Détérioration due à un choc ou des dépôts accumulés entre l'électrode centrale et le bec d'isolant pouvant provoquer des ratés d'allumage.



Surcharge thermique et soudure des électrodes dues à l'auto allumage.



Bougies BOSCH - NGK

VERGELIJKINGEN/ COMPARAISONS

BOSCH	NGK	Bic*/IX
D10B	AP5FS	
D10BC	AP5FS	
D6B	AP6FS	
D6BC	AP6FS	
D6BP	AP6FS	
D7A	A6FS	
D7AC	A6FS	
D7B	AP6FS	
D7BC	AP6FS	
D7BP	AP6FS	
D8A	A5FS	
D8AC	A5FS	
D8B	AP5FS	
D8BC	AP5FS	
D8BP	AP5FS	
D9B	AP5FS	
D9BC	AP5FS	
DR10B	APR5FS	
DR10BC	APR5FS	
DR6BC	APR6FS	
DR6BP	APR6FS	
DR7BC	APR6FS	
DR7BP	APR6FS	
DR8B	APR5FS	
DR8BC	APR5FS	
DR8BP	APR5FS	
DR9B	APR5FS	
DR9BC	APR5FS	
F04DAR	BKR6EK	BKR6EQUP
F09CS	R7115-10	
F09CS	R7114-10	
F2CS	R7114-9	
F3CS	R7114-9	
F4CS	R6205-8	
F5DC	BCP7ES	BCPR7EIX
F5DP	BCP7ES	BCPR7EIX
F5DPOR	PFR7B	
F5DTC	BCP7ET	BCP7EVX
F6DC	BCP6ES	BCPR6EIX-11
F6DC0	BCP6ES	BCPR6EIX-11
F6DCOR	BKR6E	BKR6EIX
F6DCX	BCP6ES-11	BCPR6EIX-11
F6DP	BCP6ES	BCPR6EIX-11
F6DPOR	PFR6Q	
F6DPX	BCP6ES-11	BCPR6EIX-11
F6DSR	BKR6EVX	
F6DTC	BCP6ET	BCPR6EIX-11
F6KPP332S	PFR6Q	

BOSCH	NGK	Bic*/IX
F6LTCT	BKUR7ET	PFR7Q
F6MPP332	ILFR6A	
F7DC	BCP6ES	BCPR6EIX-11
F7DC0	BCP6ES	BCPR6EIX-11
F7DCOR	BKR6E	BKR6EIX
F7DCX	BCP6ES-11	BCPR6EIX-11
F7DER	BKR6E	BKR6EIX
F7DP	BCP6ES	BCPR6EIX-11
F7DPP332	IFR6D10	
F7DTC	BCP6ET	BCPR6EIX-11
F7HER2	ZFR5P-G	
F7HPP22	BKUR6ET-10/PFR6Q	
F7HPP222	PZFR5D-11	
F7HPP222U	PZFR6J-11	
F7KPP332U	PFR6X-11	
F7KTCR	BKUR6ET-10	PFR6Q
F7LCOR2	ZFR6F-11	ZFR6FIX-11
F7LCR	ZFR6A-11	
F7LDCR	BKR6EK/BKR6EQUP	BKR6EQUP
F7LTCR	BKUR6ET-10/PFR6Q	PFR6Q
F8DC	BCP5ES	BCPR5EIX-11
F8DC4	BCP5ES	BCPR5EIX-11
F8DCO	BCP5ES	BCPR5EIX-11
F8DCOR	BCPR5ES/BKR5E	BCPR5EIX-11
F8DCX	BCP5ES-11	BCPR5EIX-11
F8DPER	IFR5D10	
F8DPP332	IFR5D10	
F8KTCR	BKUR5ET	PFR6Q
F8LCR	ZFR5F	ZFR5FIX-11
F8CLR2	ZFR5F	ZFR5FIX-11
F8LDCR	BKR6EK	BKR6EQUP
F9DCO	BCP4ES	
F9LCR	ZFR4F-11	
FGR5KQEO	BKR7EQUP	
FGR6HQEO	ZFR6S-Q	
FGR6KOC	BKR6EQUP	
FGR6KQE	BKR6EQUP	
FGR7DQEO	BKR6EKUB	BKR6EQUP
FGR7DQP	BKR6EQUP	
FGR7KQC	BKR6EQUP	
FGR7KQE	BKR6EQUP	
FGR7KQEO	BKR6EQUP	
FGR8KQEO	BKR5EQUPA	
FGR8MQPE	PLFR5A-11	
FLR8LDCU	BKR5EK	BKR5EIX
F03DAR	BCPR7ER/BKR6EK	
FQR8LEU2	ZFR5R	ZFR5FIX-11
FR10DCX	BCPR4ES-11	

BOSCH	NGK	Bic*/IX
FR10DX	BCPR4ES-11	
FR2LS	BCPR6ES	
FR5DC	BCPR7ES	BCPR7EIX
FR5DCX	BCPR7ES-11	BCPR7EIX-11
FR5DP	BCPR7ES	BCPR7EIX
FR5DTC	BCPR7ET	
FR5LDC	BKR7EKC	
FR6DC	BKR6E	BKR6EIX
FR6DC2 0,7	BKR6E	BKR6EIX
FR6DCO	BKR6EK	
FR6DCX	BCPR6ES-11	BCPR6EIX-11
FR6DDC	BKR7EKC	
FR6DP	BKR6E	BKR6EIX
FR6DP1X	PFR6J-11	
FR6DPX	BCPR6ES-11	BCPR6EIX-11
FR6DTC	BCPR6ET	
FR6DTCW	BKR5EKC	
FR6KDC	BKR6EZ	
FR6KTC	BKUR6ETB	
FR6LDC	BKR6EKC	BKR6EIX
FR6LDC	BKR6EK	BKR6EQUP
FR6MPP10	LFR6ap	
FR6Mpp10	PLFR6A	
FR7DC	BKR6E	BKR6EIX
FR7DC2	BKR6E	BKR6EIX
FR7DCO	BKR6E	BKR6EIX
FR7DCX	BCPR6ES-11	BCPR6EIX-11
FR7DE	BKR6EZ	
FR7DP	BKR6E	BKR6EIX
FR7DP1X	PFR6B-11	
FR7DPP10	BKR6EVX	
FR7DPX	BCPR6ES-11	BCPR6EIX-11
FR7DTC	BCPR6ET	
FR7HE2	ZFR5P-G	
FR7KCW	BKR6EP-13	
FR7KDC	BKR6EZ	
FR7KPP332	IZFR6H11	
FR7LC2	BKR6E	BKR6EIX
FR7LCX	ZFR6F-11	ZFR6FIX-11
FR7LDC	BKR6EKC	BKR6EIX
FR7NPP332	ILZFR6D11	
FR8DC	BKR5ES	BKR5EIX
FR8DCO	BKR5ES	BKR5EIX
FR8DCX	BKR5ES-11	BKR5EIX-11
FR8DPX	BKR5ES-11	BKR5EIX-11
FR8DS	BKR5EVX	
FR8DX	BKR5ES-11	BKR5EIX-11
FR8HP	ZFR5F-11	ZFR5FIX-11
FR8KCU	BKR5EYA-11	
FR8LCX	ZFR6F-11	ZFR6FIX-11
FR8LDC	BKR5EK	BKR5EIX
FR8LDC4	BKR5EK	BKR5EIX
FR8ME	LFR5B	
FR9DCX	BCPR4ES-11	
FR9HC	ZFR4F-11	

BOSCH	NGK	Bic*/IX
H10B	BP4FS	
H10BC	BP4FS	
H2CS	B9EFS	
H3CS	B8EFS	
H5D	BP7EFS	
H5DC	BP7EFS	
H5DCO	BP7EFS	
H5DP	BP7EFS	
H6B	BP6FS	
H6BC	BP6FS	
H6D	BP6EFS	
H6DC	BP6EFS	
H6DCO	BP6EFS	
H6DP	BP6EFS	
H7CC	B6EFS	
H7CP	B6EFS	
H7D	BP6EFS	
H7DC	BP6EFS	
H7DCO	BP6EFS	
H7DCY	BP6EFS-13	
H7DP	BP6EFS	
H7DPY	BP6EFS-13	
H8B	BP5FS	
H8BC	BP5FS	
H8BP	BP5FS	
H8DC	BP5EFS	
H8DCO	BP5EFS	
H8DCX	BP5EFS-13	
H8DP	BP5EFS	
H9B	BP4FS	
H9BC	BP4FS	
H9BCY	BPR4FS-15	
H9DC	BP5EFS	
H9DCO	BP5EFS	
H9HP	BP5EFS	
HGR6KQC	BUR6EFSZ	
HGR7KQC	BUR6EFSZ	
HR10A	BR5FS	
HR10AC	BR5FS	
HR10ACY	BR5FS-15	
HR10AY	BR5FS-15	
HR10B	BPR4FS	
HR10BC	BPR4FS	
HR10BCX	BPR4FS-11	
HR10BCY	BPR4FS-15	
HR10BX	BPR4FS-11	
HR10BY	BPR4FS-15	
HR6B	BPR6FS	
HR6BP	BPR6FS	
HR6D	BPR6EFS	
HR6DC	BPR6EFS	
HR6DP	BPR6EFS	
HR6DS	BPR6EFS	
HR7DC	BPR6EFS	
HR7MPP	PTR5A-13	

BOSCH	NGK	Bic*/IX
HR8A	BR5FS	
HR8AC	BR5FS	
HR8ACY	BR5FS-15	
HR8AP	BR5FS	
HR8APY	BR5FS-15	
HR8AY	BR5FS-15	
HR8B	BPR5FS	
HR8BC	BPR5FS	
HR8BCY	BPR5FS-15	
HR8BP	BPR5FS	
HR8BPX	BPR5FS-11	
HR8BPY	BPR5FS-15	
HR8BY	BPR5FS-15	
HR8LCO	TR5-1/SR5	TR5-1IX
HR8LPO	TR5-1/SR5	TR5-1IX
HR9A	BR5FS	
HR9AC	BR5FS	
HR9ACY	BR5FS-15	
HR9AP	BR5FS	
HR9APY	BR5FS-15	
HR9AY	BR5FS-15	
HR9B	BPR4FS	
HR9BC	BPR4FS	
HR9BCY	BPR4FS-15	
HR9BPX	BPR4FS-11	
HR9BPY	BPR4FS-15	
HR9BY	BPR4FS-15	
HR9D	BPR5EFS	
HR9DC	BPR5EFS	
HR9DCX	BPR5EFS-13	
HS5E	BM7F	
HS8E	BM6F	
M10A	A6	
M10AC	A6	
M10ACO	A6	
M10AO	A6	
M12B	A6	
M145T1	A6	
M145T5	A6	
M175T1	A6	
M225P11S	A7	
M225T1	A7	
M240T1	A7	
M280T1	A8	
M45T1	A6	
M4A	A7	
M4A1	A8	
M4A2	A7	
M4AC	A7	
M5A	A7	
M5AC	A7	
M7A	A6	
M7AC	A7	
M8A	A6	
M8AC	A6	

BOSCH	NGK	Bic*/IX
M8AO	A6	
M95T1	A6	
M95T5	A6	
MA145T1	A5FS	
MA145T7	AP5FS	
MA145TR7	APR5FS	
MA175T1	A6FS	
MA175T7	AP6FS	
MA200T7	AP6FS	
UR2AS	CR8HS	CR8HIX
UR3AS	CR7HS	CR7HIX
UR4AS	CR6HS	CR6HIX
USR7AC	CMR6H	
VR8SEW	LZKAR7A	
WO6AS	B10HVX	BR10HIX
WO6CS	B11EGV	
WO7AS	B10HVX	BR10HIX
WO7CS	B10EGV	
WO8AS	B9HVX	
WO8CS	B10EGV	
W10A	B4H	
W10AC	B4H	
W10C	B4ES	
W10CC	B4ES	
W10D	BP4ES	
W10DC	BP4ES	
W10E	B4	
W10F	BP4	
W10FC	BP4	
W125T1	B4H	
W125T2	B4ES	
W125T3	B4	
W125T30	BP5ES	BKR5EIX
W125T4	B4H	
W125TR2	BR5ES	
W125TR3	BR6S	
W125TR30	BPR5ES	BPR5EIX
W12A	B4H	
W12E	B2	
W145T1	B5HS	
W145T1,1	B5HS	
W145T2	B5ES	
W145T3	B6S	
W145T30	BP5ES	BPR5EIX
W145T35	BP5HS	
W145TR2	BR5ES	
W145TR3	BR6S	
W145TR30	BPR5ES	BPR5EIX
W175T1	B6HS	BR6HIX
W175T2	B6ES	
W175T3	B6S	
W175T30	BP6ES	BPR6EIX
W175T35	BP6HS	BPR6HIX
W175T6	BP6S	
W175T7	BP6HS	BPR6HIX

BOSCH	NGK	Bic*/IX
W175TR1	BR6HS	BR6HIX
W175TR30	BPR6ES	BPR6EIX
W175Z1	B6HS	BR6HIX
W190M11S	B6HVX	BR6HIX
W200T27	BP6ES	BPR6EIX
W200T30	BP6ES	BPR6EIX
W200T35	BP6HS	BPR6HIX
W200TR30	BPR6ES	BPR6EIX
W215P21	BP7EVX/BPR7EIX	BPR7EIX
W215T30	BP6ES	BPR6EIX
W225T1	B7HS	BR7HIX
W225T2	B7ES	
W225T3	B7S	
W225T30	BP8ES	
W225T35	BP7HS	BPR7HIX
W225T7	BPR7HS	BPR7HIX
W225TR30	BPR7ES	BPR7EIX
W230T30	BP7ES	BPR7EIX
W235T28	BP8ES	
W240M1	B8HS	BR8HIX
W240MZ1	B8HS	BR8HIX
W240T1	B8HS	BR8HIX
W240T2	B8ES	BR8EIX
W240T28	B8ES	BR8EIX
W240T3	B7S	
W250P21	BP7ES	BPR7EIX
W250T1	B8HS	BR8HIX
W250T2	B8ES	BR8EIX
W225T30	BP7ES	BPR7EIX
W260M1	B8HS	BR8HIX
W260MZ1	B8HS	BR8HIX
W260MZ1	B8HS	BR8HIX
W260MZ2	B9ES	BR9EIX
W260S1S	B8HVX	BR8HIX
W260S2S	B8EVX	BR8EIX
W260T1	B8HS	BR8HIX
W260T2	B9ES	BR9EIX
W260T20	B8ES	BR8EIX
W265P21	BPR9EVX	BPR9EIX
W275T1	B8HS	BR8HIX
W275T2	B9ES	BR9EIX
W280MZ1	B8HS	BR8HIX
W280MZ2	B9ES	BR9EIX
W280S1S	B9HVX	
W280S2S	B9EVX	BR9EIX
W280T30	BP8ES	
W2A	B9HS	
W2AC	B9HS	
W2AS	B9HVX	
W2C	B10ES	BR10EIX
W2CC	B10ES	BR10EIX
W2CO	B10ES	BR10EIX
W2CS	B10EVX	BR10EIX
W2D	BP9ES	
W300MZ2	B10ES	BR10EIX

BOSCH	NGK	Bic*/IX
W300T1	B9HS	
W300T2	B10ES	BR10EIX
W300T30	BP9ES	
W310S1S	B9HVX	
W310S2S	B10EVX	BR10EIX
W3A	B8HS	BR8HIX
W3AC	B8HS	BR8HIX
W3A0	B8HS	BR8HIX
W3AP	B8HS	BR8HIX
W3AS	B8HVX	BR8HIX
W3C	B9ES	BR9EIX
W3CC	B9ES	BR9EIX
W3CO	B9ES	BR9EIX
W3CP	B9ES	BR9EIX
W3CS	B9EVX	BR9EIX
W3D	BP8ES	
W3DP	BP8EVX	
W3DP2	BP8ES	
W3DPO	BP8EVX	
W45T1	B4H	
W4A	B8HS	BR8HIX
W4A1	B8HS	BR8HIX
W4A2	B8HS	BR8HIX
W4A5	B8HS	BR8HIX
W4AC	B8HS	BR8HIX
W4AP	B8HS	BR8HIX
W4AS	B8HVX	BR8HIX
W4C	B8ES	BR8EIX
W4C1	B8ES	BR8EIX
W4C2	B7ES	
W4C3	B7HS	BR7HIX
W4CC	B8ES	BR8EIX
W4CP	B8EVX	BR8EIX
W4CPX	B8ES-11	
W4CS	B8EVX	BR8EIX
W4DP	BP7EVX	BPR7EIX
W4DPO	BP8EVX/PFR7B	
W4E2	B7S	
W5A	B7HS	BR7HIX
W5AC	B7HS	BR7HIX
W5AP	B7HS	BR7HIX
W5AS	B7HVX	BR7HIX
W5B	BP7HS	BPR7HIX
W5BC	BP7HS	BPR7HIX
W5BP	BP7HS	BPR7HIX
W5C	B7ES	
W5CC	B7ES	
W5CCX	B7ES-11	
W5CP	B7ES	
W5CPX	B7ES-11	
W5CS	B7EVX	
W5D	BP7ES	BPR7EIX
W5D1	BP7ES	BPR7EIX
W5DC	BP7ES	BPR7EIX
W5DCO	BP7ES	BPR7EIX

BOSCH	NGK	Bic*/IX
W5DCO	BP7ES	BPR7EIX
W5DCX	BP7ES-11	
W5DP	BP7ES	BPR7EIX
W5DPO	BP7EVX	BPR7EIX
W5DPX	BP7ES-11	
W5DTC	BP6ET	PGR6D
W5E	B7S	
W5EC	B7S	
W5EP	B7S	
W6AS	B6HVX	BR6HIX
W6B	BP6HS	BPR6HIX
W6BC	BP6HS	BPR6HIX
W6BP	BP6HS	BPR6HIX
W6D	BP6HS	BPR6HIX
W6D	BP6ES	BPR6EIX
W6D1	BP6ES	BPR6EIX
W6DC	BP6ES	BPR6EIX
W6DC 0,8	BP6ES	BPR6EIX
W6DCO	BP6ES	BPR6EIX
W6DCO 0,8	BP6ESZ	PGR6D
W6DCX	BP6ES-11	BPR6EIX-11
W6DP	BP6EVX	BPR6EIX
W6DPO	BP6EVX	BPR6EIX
W6DPX	BP6EVX (1,1)	BPR6EIX
W6DTC	BP6ET	PGR6D
W7A	B6HS	BR6HIX
W7AC	B6HS	BR6HIX
W7AO	B6HS	BR6HIX
W7AP	B6HS	BR6HIX
W7B	BP6HS	BPR6HIX
W7BC	BP6HS	BPR6HIX
W7BP	BP6HS	BPR6HIX
W7C	B6ES	
W7CC	B6ES	
W7CCO	B6ES	
W7CCX	B6ES-11	
W7CP	B6ES	
W7CPX	B6ES-11	
W7CX	B6ES-11	
W7D	BP6ES	BPR6EIX
W7D0	BP6ES	BPR6EIX
W7DC	BP6ES	BPR6EIX
W7DC0	BP6ESZ	PGR6D
W7DCR	BPR6ES	BPR6EIX
W7DCX	BP6ES-11	BPR6EIX-11
W7D0	BP6ES	BPR6EIX
W7DP	BP6ES	BPR6EIX
W7DPX	BP6ES-11	BPR6EIX-11
W7DTC	BP6ET	PGR6D
W7DTC 1,0	BP6ET	PGR6D
W7DX	BP6ES-11	BPR6EIX-11
W7E	B6S	
W7EC	B6S	
W7EP	B6S	
W7F	BP6S	

BOSCH	NGK	Bic*/IX
W7FC	BP6S	
W7LTCR	BUR6ET	PGR6D
W8A	B5HS	
W8AC	B5HS	
W8AO	B5HS	
W8AP	B5HS	
W8B	BP5HS	
W8BC	BP5HS	
W8BP	BP5HS	
W8C	B5ES	
W8CCX	B5ES-11	
W8CO	B5ES	
W8CP	B5ES	
W8D	BP5ES	BPR5EIX
W8DC	BP5ES	BPR5EIX
W8DCO	BP5ES	BPR5EIX
W8DCX	BP5ES-11	BPR5EIX-11
W8DCY	BPES-13	
W8DP	BP5ES	BPR5EIX
W8DPX	BP5ES-11	BPR5EIX-11
W8DTC	BP5ET	
W8DX	BPES-11	BPR5EIX-11
W8E	B6S	
W8EC	B6S	
W8F	BP5S	
W8FC	BP5S	
W8LCR	ZGR5A	
W8LDCR	BUR6ET	PGR6D
W8LPR	ZGR5A	
W8LTCR	BUR5ET/BPR5EIKU	PGR6D
W8LTCR 1,0	BUR5ET-10	PGR6D
W8LTCREA	BUR5ET	
W95T1	B4H	
W95T2	B4ES	
W95T3	B4	
W95T30	BP4ES	
W95T6	BP4	
W9A	B4H	
W9AC	B5HS	
W9ACO	B5HS	
W9AO	B4H	
W9C	B4ES	
W9CC	B4ES	
W9D	BP5ES	BPR5EIX
W9DC	BP5ES	BPR5EIX
W9DCX	BP5ES-11	BPR5EIX-11
W9DP	BP5ES	BPR5EIX
W9DPX	BP5ES-11	BPR5EIX-11
W9DTC	BP5ET	
W9E	B4	
W9EC	B4	
W9ECO	B4LM	
W9EO	B4LM	
W9F	BP5S	
W9FC	BP5S	

BOSCH	NGK	Bic*/IX
W9LC	ZGR5A	
WA125TR30	BPR5EFS	
WA200T30	BP6EFS	
WA200TR30	BPR6EFS	
WA225T30	BP7EFS	
WAK145T3	BM6F	
WAK225T3	BM7F	
WEA	BUH	
WEC	BUE	
WET1	BUH	
WET2	BUE	
WG235T28	BP7ES	BPR7EIX
WG250P21	BPR9EVX	BPR9EIX
WG250T28	BP8EVX	
WG250T30	BP8ES	
WG265T2SP	BPR9EVX	BPR9EIX
WKA145T3	BM6A	
WKA146T6	BPM6A	
WKA175T3	BM6A	
WKA225T3	BM7A	
WKA225T6	BPM7A	
WO6CS	B11EGV	
WR10A	BR4HS	
WR10AC	BR4HS	
WR10E	BR6S	
WR10F	BP4	
WR10FC	BP4	
WR10FCY	BPR4S-15	
WR10FY	BPR4S-15	
WR10LCV	BPR4ES-13	
WR11E0	BR4LM	
WR4AC	BR8HS	BR8HIX
WR4CC	BR8ES	BR8EIX
WR4CP	BR8EVX	BR8EIX
WR5A	BR7HS	BR7HIX
WR5AC	BR7HS	BR7HIX
WR5CC	BR7ES	
WR5CP	BR7ES	
WR5D	BPR7ES	BPR7EIX
WR5DC	BPR7ES	BPR7EIX
WR5DP	BPR7ES	BPR7EIX
WR5DS	BPR7EVX	BPR7EIX
WR6D	BPR6ES	BPR6EIX
WR6DC	BPR6ES	BPR6EIX
WR6DCX	BPR6ES-11	BPR6EIX-11
WR6DP	BPR6ES	BPR6EIX
WR6DPX	BPR6ES-11	BPR6EIX-11
WR6DS	BPR6EVX	BPR6EIX
WR6DTC	BP6ET	PGR6D
WR6DTC	BUR6ETB-10	
WR7A	BR6HS	BR6HIX
WR7AC	BR6HS	BR6HIX
WR7B	BPR6HS	BPR6HIX
WR7BC	BPR6HS	BPR6HIX
WR7BP	BPR6HS	BPR6HIX

BOSCH	NGK	Bic*/IX
WR7C	BR6ES	
WR7CC	BR6ES	
WR7CCX	BR6ES-11	
WR7CP	BR6ES	
WR7CPX	BR6ES-11	
WR7D	BPR6ES	BPR6EIX
WR7DC	BPR6ES	BPR6EIX
WR7DC2	BPR6ES	BPR6EIX
WR7DCX	BPR6ES-11	BPR6EIX-11
WR7DP	BPR6EVX	BPR6EIX
WR7DS	BPR6EVX	BPR6EIX
WR7F	BP6S	
WR7F	BPR6S	
WR8AC	BR5HS	
WR8C	BR5ES	
WR8CC	BR5ES	
WR8CP	BR5ES	
WR8D	BPR5ES	BPR5EIX
WR8DC	BPR5ES	BPR5EIX
WR8DC0	BPR5ES	BPR5EIX
WR8DCX	BPR5ES-11	BPR5EIX-11
WR8DP	BPR5ES	BPR5EIX
WR8DPX	BPR5ES-11	BPR5EIX-11
WR8DPY	BPR5ES-15	
WR8DS	BPR5EVX	BPR5EIX
WR8E	BR6S	
WR8EC	BR6S	
WR8EP	BR6S	
WR8F	BPR5S	
WR8F	BP5S	
WR8FC	BPR5S	
WR8FC	BP5S	
WR8FP	BP5S	
WR8FP	BPR5S	
WR8FPY	BPR5S-15	
WR8HP	ZGR5C	
WR9A0	BR5HS	
WR9C	BR5ES	
WR9CC	BR5ES	
WR9D	BPR5ES	BPR5EIX
WR9DC	BPR5ES	BPR5EIX
WR9DCX	BPR5ES-11	BPR5EIX-11
WR9DCY	BPR5ES-15	
WR9DP	BPR5ES	BPR5EIX
WR9DPX	BPR5ES-11	BPR5EIX-11
WR9DS	BPR5EVX	BPR5EIX
WR9DY	BPR5ES-15	
WR9E	BR6S	
WR9EC	BR6S	
WR9ECO	BR6S/BM6	
WR9EO	BR6S	
WR9F	BP5S	
WR9F	BPR5S	
WR9FC	BP5S	
WR9FC	BPR5S	

BOSCH	NGK	Bic*/IX
WR9FCY	BPR5S-15	
WR9FP	BP5S	
WR9FPY	BPR5S-15	
WR9FY	BPR5S-15	
WR9HC	ZGR5C	
WR9HP	ZGR5C	
WR9LS	ZGR5A	
WS5E	BM7A	
WS5F	BPM7A	
WS7E	BM6A	
WS8E	BM6A	
WS8F	BPM6A	
WSR5F	BPMR7A	
WSR6F	BPMR7A	
WSR8F	BPMR6A	
WSR9E	BMR4A	
X3CPO	D9EA	DR9EIX
X4CS	D8EA	DR8EIX
X5DC	D7EA	
XR2AS	DR8HS	
XR2CS	DR8ES	DR8EIX
XR4AS	DR8HS	
XR2CS	DR8ES	DR8EIX
XR4AS	DR8HS	
XR4CS	DR8ES	DR8EIX
XR5DC	DR7EA	
Y6DC		
YMPP33	PLKR6A	
YR5DDE	KR9CI	
YR5LDE	DCPR8EKC	
YR7DE	DCPR8EN	DCPR8EIX
ZR8TPP15	LFR5B	

Bougies CHAMPION - NGK

VERGELIJKINGEN/ COMPARAISONS

CHAMPION	NGK	Bic*/IX
5828/QL77JC4	BZ7HS-10	
5838/QL78V	BUZHW-2	
5883/QL78C	BR7HS	BR7HIX
5898/QL76V	BUZHW	
5931/RL82C	BR6HS	BR6HIX
5933/L86CC	B6HS	BR6HIX
5939/QL78YC	BPR7HS	BPR7HIX
5942/RV15YC4	BPR4FS-11	
860	A6FS	
870	A5FS	
A10	D7EA	
A4HC	DP9EA-9	DPR9EIX-9
A50R	R2198-12P	
A50R	R2525-11	
A51R	R2525-10	
A51R	R2198-11P	
A53C	R2525-11	
A53R	R2525-11	
A53R	R2198-10P	
A55C	R2525-10	
A55R	R2525-10	
A55V	R2270-11	
A57C	R2525-10	
A57G	R2525-10	
A57R	R2525-10	
A59C	R2525-9	
A59C	D9EA	DR9EIX
A59G	D9EVX	DR9EIX
A59G	R2525-9	
A59GC	R2430-9 DUCATI	
A59GC	DCPR9EVX	DCPR9EIX
A5YC	DP9EA-9	DPR9EIX-9
A6	D8EA	DR8EIX
A61	D9EA	DR9EIX
A61G	D9EVX	DR9EIX
A6G	D8EVX	DR8EIX
A6GC	D8EVX	DR8EIX
A6HC	DP8EA-9	DPR8EIX-9
A6Y	DP8EA-9	DPR8EIX-9
A6YC	DP8EA-9	DPR8EIX-9
A8	D7EA	
A8YA	DP7EA-9	DPR7EIX-9
A8YC	DP7EA-9	DPR7EIX-9
BL11Y	BP5FS	
BL13Y	BP5FS	
BL4	B7FS	
BL5	B7FS	
BL6	B6FS	
BL7Y	BP7FS	

CHAMPION	NGK	Bic*/IX
BL8	B6FS	
BL9Y	BP6FS	
BN12Y	BP5EFS	
BN2	B9EFS	
BN6Y	BP7EFS	
BN7Y	BP6EFS	
BN89Y	BP6EFS	
BN9Y	BP6EFS	
C10YCC	BCP5ES	BCPR5EIX-11
C10YCC	BCP6ES	BCPR6EIX-11
C11YCC	BCP5ES	BCPR5EIX-11
C281YC	BCP6ES	BCPR6EIX-11
C55	R7234-10	
C55 R	R7234-10	
C57	R7234-9	
C57C	R7234-9	
C59	R7234-9	
C59C	R7234-9	
C59YC	R5672A-9	
C61	R7234-8	
C6BYC	BCP7ET	BCP7EVX
C6VPYC	BKR7EVX-11	BKR7EIX-11
C6YCC	BCP7ES	BCPR7EIX
C7Y	BCP7ES	BCPR7EIX
C7YC	BCP7ES	BCPR7EIX
C7YCC	BCP7ES	BCPR7EIX
C7YCX	BCP7ES	BCPR7EIX
C9MCC	ZFR5F	ZFR5FIX-11
C9Y	BCP6ES	BCPR6EIX-11
C9YC	BCP6ES	BCPR6EIX-11
C9YCC	BCP6ES	BCPR6EIX-11
C9YCX	BCP6ES	BCPR6EIX-11
CJ11	BM6A	
CJ14	BM4A	
CJ17LM	B4LM	
CJ3	BM7A	
CJ4	BM7A	
CJ6	BM7A	
CJ6Y	BPM7A	
CJ7Y	BPM7A	
CJ8	BM6A	
CJ86	BM6A	
CJ8Y	BPM6A	
D10	A6	
D14	A6	
D16	A6	
D16J	A6	
D21	A6	
D6	A8	

CHAMPION	NGK	Bic*/IX
D9	A6	
D9J	A6	
DJ6J	BM7F	
DJ6Y	BPM7F	
DJ7J	BM6F	
DJ7Y	BPM6F	
DJ8J	BM6F	
F10	A6FS	
F10C	A6FS	
F11Y	AP5FS	
F14Y	AP5FS	
F62Y	AP8FS	
F7Y	AP7FS	
F7YC	AP7FS	
F7YCC	AP7FS	
F81Y	AP8FS	
F-82	A8F	
F83Y	AP8FS	
F9Y	AP6FS	
F9YC	AP6FS	
FN507Y	BCP7ES	BCPR7EIX
G56R	R016-10	
G63R	R016-8	
G1	C9E	CR9EIX
G2	C8E	CR8EIX
G54V	R0045J-10	
G55	C9E	CR9EIX
G58	C9E	CR9EIX
G59C	C7E	CR7EIX
G61	C8E	CR8EIX
G63R	C8E	CR8EIX
H03	B6S	
H10	B6L	
H10C	B6L	
H10J	B6L	
H11	B4L	
H12	B4L	
H8	B6L	
H8J	B6L	
J10Y	BP6S	
J11	B4	
J11C	B4	
J11J	B4	
J11Y	BP5S	
J12J	B2	
J12Y	BP5S	
J12YC	BP5S	
J13Y	BP5S	
J14J	B2	
J14Y	BP5S	
J14YC	BP5S	
J17LM	B4LM	
J18Y	BP4	
J18YC	BP4	
J19LM	B2LM	

CHAMPION	NGK	Bic*/IX
J2J	B9S	
J4	B7S	
J4C	B7S	
J4J	B7S	
J5	B7S	
J6	B6S	
J6C	B6S	
J6J	B6S	
J7	B6S	
J7J	B6S	
J8	B6S	
J8C	B6S	
J8J	B6S	
K13	A6	
K15J	A6	
K3G	A8	
K5G	A8	
K7	A8	
K-8	A8	
K8G	A8	
K9	A7	
L10	B6HS	BR6HIX
L12Y	BP5HS	
L14	B4H	
L15Y	BP4HS	
L19V	BUH	
L20V	BUH	
L288	B5HS	
L2G	B9HVX	
L3G	B8HVX	BR8HIX
L4G	B7HVX	BR7HIX
L4J	B7HS	BR7HIX
L5	B7HS	BR7HIX
L55G	B10HVX	BR10HIX
L61Y	BP8HS	BPR8HIX
L64Y	BP7HS	BPR7HIX
L66Y	BP6HS	BPR6HIX
L6G	B7HVX	BR7HIX
L6VC	BU8H	
L76V	BUHW	
L77J	B7HS	BR7HIX
L77J4	B7HS-10	
L77JC	B7HS	BR7HIX
L77JC4	B7HS-10	
L77V	BUHW	
L78	B7HS	BR7HIX
L78C	B7HS	BR7HIX
L78V	BUHW-2	
L78YC	BP7HS-10	
L78YC6	BP8HS-15	
L7J	B6HS	BR6HIX
L81	B7HS	BR7HIX
L81Y	BP7HS	BPR7HIX
L82	B6HS	BR6HIX
L82C	B6HS	BR6HIX

CHAMPION	NGK	Bic*/IX
L82Y	BP6HS	BPR6HIX
L82YC	BP6HS	BPR6HIX
L82YCC	BP6HS	BPR6HIX
L85	B6HS	BR6HIX
L85Y	BP6HS	BPR6HIX
L86	B6HS	BR6HIX
L86C	B6HS	BR6HIX
L86CC	B6HS	BR6HIX
L87Y	BP6HS	BPR6HIX
L87YC	BP6HS	BPR6HIX
L87YCC	BP6HS	BPR6HIX
L89CM	BP5HS	
L90	B5HS	
L90C	B5HS	
L92LCC	BP5HA	
L92Y	BP5HS	
L92YC	BP5HS	
L95Y	BP4HS	
L9G	B6HVX	BR6HIX
L9J	B6HS	BR6HIX
N1	B10ES	BR10EIX
N10PY	BP6EVX	BPR6EIX
N10Y	BP6ES	BPR6EIX
N10Y4	BP6ES-11	BPR6EIX-11
N11Y	BP5ES	BPR5EIX
N11YC	BP5ES	BPR5EIX
N11YC4	BP5ES-11	BPR5EIX-11
N11YCC	BP5ES	BPR5EIX
N12Y	BP5ES	BPR5EIX
N12YC	BP5ES	BPR5EIX
N12YCC	BP5ES	BPR5EIX
N13L	ZGR5C	
N13Y	BP5ES	BPR5EIX
N14LY	ZGR5C	
N14Y	BP5ES	BPR5EIX
N16Y	BP4ES	
N16YC	BP4ES	
N178B	B8EM	
N180B	B7EM	
N19V	BUE	
N1C	B10ES	BR10EIX
N2	B9ES	BR9EIX
N21	B4ES	
N279YC	BP7ES	BPR7EIX
N281YC	BP6ES	BPR6EIX
N288	B5ES	
N2C	B9ES	BR9EIX
N2G	B9EVX	BR9EIX
N3	B8ES	BR8EIX
N3C	B8ES	BR8EIX
N3G	B8EVX	BR8EIX
N4	B7ES	
N4C	B7ES	
N4G	B7EVX	
N4YC	BP9ES	

CHAMPION	NGK	Bic*/IX
N5	B6ES	
N52R		
N54R	B10EG	
N55G	B105EGV	
N56R	B105EGP	
N57	B10ES	BR10EIX
N57G	B105EGV	
N57R	B10EG	
N59G	B95EGV	
N5C	B6ES	
N5G	B6EVX	
N6	B6ES	
N60	B9ES	BR9EIX
N60R	B8EG	
N60Y	BPR10EVX	
N62R	B8EG	
N63Y	BP9ES	
N64Y	BP8ES	
N65Y	BP7ES	BPR7EIX
N66Y	BP6ES	BPR6EIX
N6BYC	BP6ET	PGR6D
N6GY	BP8EVX	
N6Y	BP8ES	
N6YC	BP8ES	
N6YCC	BP8ES	
N7	B7ES	
N74C	BUR6EB-11/B6EB-11	
N79Y	BP6ES	BPR6EIX
N7BMC	BP6ET	PGR6D
N7BYC	BP6ET	PGR6D
N7GY	BP7EVX	BPR7EIX
N7Y	BP7ES	BPR7EIX
N7YC	BP7ES	BPR7EIX
N7YCC	BP7ES	BPR7EIX
N7YCX	BP7ES	BPR7EIX
N8	B6ES	
N80	B10EG	
N80G	B11EGV	
N82	B10EG	
N82G	B105EGV	
N84	B9EG	
N84G	B95EGV	
N86	B9EG	
N86G	B9EGV	
N87	B8EG	
N87G	B8EGV	
N8GY	BP6EVX	BPR6EIX
N8L	ZGR5C	
N8Y	BP6ES	BPR6EIX
N9BMC	BPR5EKU	PGR6D
N9BYC	BP6ET	PGR6D
N9BYC4	BP5ET-10	
N9Y	BP6ES	BPR6EIX
N9YC	BP6ES	BPR6EIX
N9YC4	BP6ES-11	BPR6EIX-11

CHAMPION	NGK	Bic*/IX
N9YCC	BP6ES	BPR6EIX
N9YCX	BP6ES	BPR6EIX
OBL9Y	BPR6FS	
OE001/r04	BP6ES	BPR6EIX
OE001/t10	BP6ES	BPR6EIX
OE002/r04	BKR6E	BKR6EIX
OE002/t10	BKR6E	BKR6EIX
OE003/T10	BCP6ES	BCPR6EIX-11
OE004/r04	BPR6ES	BPR6EIX
OE004/r04	GR5	
OE004/t10	GR5	
OE004/t10	BPR6ES	BPR6EIX
OE005/r04	BKR6E	BKR6EIX
OE005/t10	BKR6E	BKR6EIX
OE006/r04	GR5	
OE006/r04	BPR6ES	BPR6EIX
OE006/t10	GR5	
OE007/t10	BP6HS	BPR6HIX
OE008/r04	BPR7ES	BPR7EIX
OE008/t10	BPR7ES	BPR7EIX
OE009/r04	BP7EFS	
OE009/t10	BP7EFS	
OE010/r04	BP7ES	BPR7EIX
OE010/t10	BP7ES	BPR7EIX
OE011/r04	BPR6EFS	
OE011/T10	BPR6EFS	
OE012/r04	BP6ET	PGR6D
OE012/t10	BP6ET	PGR6D
OE013/t10	BKR5ES	BKR5EIX
OE014/r04	BCPR7ES	BCPR7EIX
OE014/t10	BCPR7ES	BCPR7EIX
OE015/t10	BP5ES	BPR5EIX
OE016/r04	BKR6E	BKR6EIX
OE016/t10	BKR6E	BKR6EIX
OE017/T10	BCP7ES	BCPR7EIX
OE018/r04	BCPR7ES	BPR7EIX
OE018/t10	BPR7ES	BPR7EIX
OE019/r04	BKR5EK	BKR5EIX
OE019/t10	BKR5EK	BKR5EIX
OE020/R04	BPR6EFS	
OE020/t10	BPR6EFS	
OE021/r04	BCPR6ET	
OE021/t10	BCPR6ET	
OE023/R04	BCP6ES	BCPR6EIX-11
OE023/T10	BCP6ES	BCPR6EIX-11
OE025/r04	BUR6ET	PGR6D
OE025/t10	BUR6ET	PGR6D
OE026/r04	BKR6EK	BKR6EQUP
OE026/t10	BKR6EK	BKR6EQUP
OE027/r04	BUR5ET-10	PGR6D
OE027/T10	BUR5ET-10	PGR6D
OE028/r04	BP5ET-10	
OE028/t10	BP5ET-10	
OE030/t10	BKR6EKC	BKR6EIX
OE031/r04	PTR5A-13	

CHAMPION	NGK	Bic*/IX
OE031/t10	PTR5A-13	
OE032/r04	BUR6ET-10	
OE032/r04	BKUR6ET-10	PFR6Q
OE032/t10	BUR6ET-10	
OE032/t10	BKUR6ET-10	PFR6Q
OE033/t10	PFR6G-9	
OE033/t10	BKR6EZ	
OE034/t10	BKR6ES	BKR6EIX
OE035/t10	LFR5B	
OE036/r04	BP7EFS	
OE036/t110	BP7EFS	
OE037/T10	B6HS	BR6HIX
OE038/T10	BP6HS	BPR6HIX
OE039/t10	BCPR6ES-11	BCPR6EIX-11
OE040/t10	B9ES	BR9EIX
OE041/t10	ZFR5F	ZFR5FIX-11
OE042/t10	BPR5ES	BPR5EIX
OE043/r04	BCPR7ES	BCPR7EIX
OE043/t10	BCPR7ES	BCPR7EIX
OE044/t10	BP6ET	PGR6D
OE045/t10	BPR5ES	BPR5EIX
OE048/r04	BPR6ES-11	BPR6EIX-11
OE048/t10	BPR6ES-11	BPR6EIX-11
OE049/t10	BPR5ES-11	BPR5EIX-11
OE050/r04	BP7EFS	
OE050/t10	BP7EFS	
OE051/t10	BPR5ES	BPR5EIX
OE054/t10	APR6FS	
OE056/r04	BKR7ES-11	BKR7EIX-11
OE056/t10	BKR7ES-11	BKR7EIX-11
OE057/T10	BCP5ES	BCPR5EIX-11
OE058/T10	BCP7ES	BCPR7EIX
OE059/T10	BP5HS	
OE060/t10	ZGR5B	
OE063/t10	BCPR6ES-11	BCPR6EIX-11
OE064/r04	BPR6HS	BPR6HIX
OE064/T10	BPR6HS	BPR6HIX
OE065/T10	BP5ES	BPR5EIX
OE066/r04	ZFR6F	
OE067/t10	BP7EFS	
OE068/t10	B8ES	BR8EIX
OE072/t10	BPR5EFS	
OE073/t10	DCPR9E	DCPR9EIX
OE074/t10	B6ES	
OE075/T10	BCP7ES	BCPR7EIX
OE076/T10	BCP7ET	BCP7EVX
OE077/t10	BCPR6ET	
OE078/t10	B8EVX	BR8EIX
OE079/t10	B7ES	
OE080/t10	BKR7ES-11	BKR7EIX-11
OE083/t10	DCPR8E	DCPR8EIX
OE083/t10	DPR8EA-9	DPR8EIX-9
OE084/R04	BP8ES	
OE084/t10	BP8ES	
OE085/t10	BKR5EKU	

CHAMPION	NGK	Bic*/IX
OE086/t10	BR6HS	BR6HIX
OE087/r04	BP8ES	
OE087/t10	BP8ES	
OE090/t10	BP7EFS	
OE091/t10	BR9ES	BR9EIX
OE092/t10	CR9E	CR9EIX
OE093/t10	BKR5EZ	
OE095/r04	BP6ET	PGR6D
OE095/T10	BP6ET	PGR6D
OE098/t10	BR7ES	
OE099/t10	BPR5EFS	
OE100/t10	BPR5EKU	PGR6D
OE103/T10	R2430-9 DUCATI	
OE103/T10	DCPR9EVX	DCPR9EIX
OE105/t10	GR4	GR4IX
OE108/T10	BR8ES	BR8EIX
OE109/t10	BP6ET	PGR6D
OE110/t10	BCPR7ES	BCPR7EIX
OE112/T10	D8EVX	DR8EIX
OE116/t10	BPR8ES	
OE122/t10	PMR8A	
OE124/t10	PFR5J-11	
OE124/t10	PFR5G	
OE125/t10	B9EVX	BR9EIX
OE129/T10	BKR7EVX-11	BKR7EIX-11
OE130/t10	LZKAR7A	
OE132/T10	DP8EA-9	DPR8EIX-9
OE134/t10	PFR5J-11	
OE136/t10	PFR6J-11	
OE141/t10	BKR6EVX 0,8	
OE143/t10	PFR6G-9	
OE144/t10	BKUR6ET-10	PFR6Q
OE145/t10	BKUR6ET-10	PFR6Q
OE146/t10	PFR5G-13E	
OE151/T06	BPR5EFS	
OE151/T06	TR4	
OE152/t10	BKR5E-11	BKR5EIX-11
OE155/t10	APR6FS	
OE156/t10	ZGR5C	
OE160/t06	ZFR4F-11	
OE161/t04	GR4	GR4IX
OE162/t06	BR6ES	
OE163/t04	LTZR4A-11	
OE165/T04	R7234-9	
OE166/T04	C7E	CR7EIX
OE169/t04	R5724-9	
OE171/t04	BPR6FS	
OE171/t04	UR6	
OE173/T04	R2525-10	
OE175/t10	LFR5AP-11	
OJ11Y	BP6S	
OJ12Y	BP5S	
OJ13Y	BP5S	
ON11Y	BPR5ES	BPR5EIX
ON12Y	BPR5ES	BPR5EIX

CHAMPION	NGK	Bic*/IX
ON3	BR8ES	BR8EIX
P10Y	D6HA	
P7	D8HA	
P7G	DR8HS	
P8Y	D6HA	
PG2PHP	PMR8A	
PG4PHP	PMR7A	
PZ7HC	C7HSA	CR7HIX
QC12PEP	PZFR6H	
QC12YC	BKR5ES	BKR5EIX
QC59YC	BKR8E	
QL16V	BU8H	
QL6VC	BU8H	
QL76V	BUZHW	
QL77CC	BR8HS	BR8HIX
QL77J4	BZ7HS-10	
QL77JC4	BZ7HS-10	
QL78C	BR7HS	BR7HIX
QL78V	BUZHW-2	
QL78YC	BPR7HS	BPR7HIX
QL7J5	BR6HS	BR6HIX
QL81Y	BPZ7HS-10	
QL82C	BR6HS	BR6HIX
QL82YC	BPR6HS	BPR6HIX
QL86	BR6HS	BR6HIX
QL87YC	BPR6HS	BPR6HIX
QL92LCC	BP8HS-10	
QN2	BR9ES	BR9EIX
QN2C	BR9ES	BR9EIX
QN2G	BR9EVX	BR9EIX
QN3	BR8ES	BR8EIX
QN3C	BR8ES	BR8EIX
QN84	BR9EG	
QN86	BR8EG	
R10	D6EA	
R44CXLS	BPR5ES	BPR5EIX
R54G	R 217-11	
R6	D8EA	DR8EIX
R6G	D8EVX	DR8EIX
R8	D7EA	
RA2HC	DPR9EA-9	DPR9EIX-9
RA4HC	DPR9EA-9	DPR9EIX-9
RA4HC	DCPR9E	DCPR9EIX
RA4HCC	DCPR8E	DCPR8EIX
RA59GC	DCPR9EVX	DCPR9EIX
RA59PP	D9EVX	DR9EIX
RA6	DR8ESL	DR8EIX
RA6HC	DPR8EA-9	DPR8EIX-9
RA6HC	DCPR8E	DCPR8EIX
RA6Y	DPR8EA-9	DPR8EIX-9
RA6YC	DPR8EA-9	DPR8EIX-9
RA8HC	DCPR7E	DCPR7EIX
RA8Y	DPR7EA-9	DPR7EIX-9
RA8YC	DPR7EA-9	DPR7EIX-9
RBL11Y	BPR5FS	

CHAMPION	NGK	Bic*/IX
RBL11YS	BPR5FS-15	
RBL12	BR5FS	
RBL12-6	BR5FS-15	
RBL13Y	BPR5FS	
RBL13Y6	BPR5FS-15	
RBL15Y	BPR4FS	
RBL15Y4	BPR4FS-11	
RBL15Y6	BPR4FS-15	
RBL16Y	BPR4FS	
RBL17Y	BPR4FS	
RBL17Y6	BPR4FS-15	
RBL8	BR6FS	
RBL8-6	BR6FS-15	
RBL9Y	BPR6FS	
RBN12Y	BPR5EFS	
RBN13Y	BPR5EFS	
RBN14Y	BPR5EFS	
RBN9Y	BPR6EFS	
RC10DMC	BKR5EK	BKR5EIX
RC10ECC	ZFR6F-11	ZFR6FIX-11
RC10PYC	BKR6EVX 0,8	
RC10PYP4	PFR5G	
RC10PYP4	PFR5J-11	
RC10VTYC4	BPR5EKUP	
RC10YC4	BCPR6ES-11	BCPR6EIX-11
RC10YCC	BKR6E	BKR6EIX
RC11LCC4	BRE527Y-11	
RC12LYC	ZFR5F	ZFR5FIX-11
RC12MC4	PZFR5F-11	
RC12MC5	ZFR5F-11	ZFR5FIX-11
RC12PYP	PFR5J-11	
RC12YC	BKR5ES	BKR5EIX
RC12YC5	FR45	
RC14YC	BKR5ES	BKR5EIX
RC14YC4	BKR5E-11	BKR5EIX-11
RC6VPYC	BKR7EVX-11	BKR7EIX-11
RC6YC	BCPR7ES	BCPR7EIX
RC7BMC	BCPR6ET	
RC7BYC4	BCPR6ET	
RC7GYC	BKR7EVX-11	BKR7EIX-11
RC7Y	BCPR7ES	BCPR7EIX
RC7YC	BCPR7ES	BCPR7EIX
RC7YC4	BKR7ES-11	BKR7EIX-11
RC7YCC	BCPR7ES	BCPR7EIX
RC7YCC4	BKR7ES-11	BKR7EIX-11
RC87PYC	BKUR6ET-10	PFR6Q
RC87YCL	PFR6G-9	
RC87YCL	BKR6EZ	
RC89PYC	BKUR5ET-10	
RC89YCC	BKR5EZ	
RC8BYC	BKR6EKC	BKR6EIX
RC8DMC	BKR6EK	BKR6EQUP
RC8PYCB	PFR6G-9	
RC8PYP	PFR6J-11	
RC8PYPB4	PFR5G-13E	

CHAMPION	NGK	Bic*/IX
RC8PYX	FR7KDC	
RC8VTYC4	BKUR5ET	
RC8YC4	BKR5E-11	BKR5EIX-11
RC8YCL	BKR6ES	BKR6EIX
RC9BMC	BKR5EKU	
RC9MC4	ZFR5F-11	ZFR5FIX-11
RC9MCC	ZFR6F	
RC9Y	BKR6E	BKR6EIX
RC9YC	BKR6E	BKR6EIX
RC9YC4	BCPR6ES-11	BCPR6EIX-11
RC9YCC	BKR6E	BKR6EIX
RCJ4	BMR7A	
RCJ6	BMR7A	
RCJ6Y	BPMR7A	
RCJ7Y	BPMR7A	
RCJ8	BMR6A	
RCJ8Y	BPMR6A	
RD14	A6	
RD16	A6	
RD16J	A6	
RD9	A6	
RDJ6J	BM7F	
RDJ7J	BMR6F	
RDJ7Y	BPMR6F	
RDJ8J	BMR6F	
RE10LC	SR5	
RE14MCC5	LZTR4A-11	
RE14PLP5	PLZTR5a-13	
RE7PYC5	PTR5A-13	
RE7YCC	PTR5A-13	
REA8MCL	LZKAR7A	
REA8MCL	LZKAR7A	
REC10PYC4	LFR5AP-11	
REC14PYC	LFR4AP-11	
REC9YCL	LFR5B	
RES9YCC4	PTR5A-13	
RF10	AR6FS	
RF10C	AR6FS	
RF11Y	APR6FS	
RF11YC	WR5	
RF11YC	APR6FS	
RF12-5	AR5FS-11	
RF14Y	APR5FS	
RF7YC	APR6FS	
RF7YCC	APR6FS	
RF9Y	APR6FS	
RF9Y5	APR6FS	
RF9YC	WR5	
RF9YC	APR6FS	
RFN14LY	ZFR4F-11	
RG2PHP	CR8EVX	CR8EIX
RG4HC	CR9E	CR9EIX
RG4PHP	PMR7A	
RG4PHP	PMR8A	
RG6YC	CR8EB	CR8EIX

CHAMPION	NGK	Bic*/IX
RG6YCH	CPR8E	
RG94C	CR8E	CR8EIX
RH10C	B6L	
RH10C	B6L	
RH8C		
RJ10Y	BP6S	
RJ11	BR6S	
RJ11Y	BP5S	
RJ12C	BR6S	
RJ12Y	BP5S	
RJ12YC	XR5	
RJ12YC	BP5S	
RJ14CC	XR4	
RJ14Y	BP5S	
RJ14YC	BP5S	
RJ14YC	XR4	
RJ14YC	XR4	
RJ17LM	BR4LM	
RJ18Y	BP4	
RJ18YC	XR4	
RJ18YC	BP4	
RJ19LM	BR2LM	
RJ20Y	BP4	
RJ6	BR6S	
RJ6C	BR6S	
RJ6J	BR6S	
RJ7	BR6S	
RJ8	BR6S	
RJ8C	BR6S	
RJ8J	BR6S	
RL12Y	BPR6HS	BPR6HIX
RL19	BR5HS	
RL4J	BR7HS	BR7HIX
RL77J	BR7HS	BR7HIX
RL78	BR7HS	BR7HIX
RL78C	BR7HS	BR7HIX
RL7J	BR6HS	BR6HIX
RL82	BR6HS	BR6HIX
RL82C	BR6HS	BR6HIX
RL82Y	BPR6HS	BPR6HIX
RL82YC	BPR6HS	BPR6HIX
RL82YCC	BPR6HS	BPR6HIX
RL85	BR6HS	BR6HIX
RL85G		
RL86	BR6HS	BR6HIX
RL86C	BR6HS	BR6HIX
RL87Y	BPR6HS	BPR6HIX
RL87YC	BPR6HS	BPR6HIX
RL82YCC	BPR6HS	BPR6HIX
RL85	BR6HS	BR6HIX
RL85G		
RL86	BR6HS	BR6HIX
RL86C	BR6HS	BR6HIX
RL87Y	BPR6HS	BPR6HIX
RL87YC	BPR6HS	BPR6HIX

CHAMPION	NGK	Bic*/IX
RL90	BR5HS	
RL95YC	BPR5HS	
RN10GY	BPR6EVX	BPR6EIX
RN10VTYC	BUR5ET	PGR6D
RN10VTYC4	BUR5ET-10	PGR6D
RN10Y	BPR6ES	BPR6EIX
RN10Y4	BPR6ES-11	BPR6EIX-11
RN11Y	BPR5ES	BPR5EIX
RN11YC	BPR5ES	BPR5EIX
RN11YC4	BPR5ES-11	BPR5EIX-11
RN11YCC	BPR5ES	BPR5EIX
RN12GY	BPR5EVX	BPR5EIX
RN12MC4	BPR4EY-11	
RN12Y	BPR5ES	BPR5EIX
RN12YC	BPR5ES	BPR5EIX
RN12YC4	BPR5ES-11	BPR5EIX-11
RN12YC6	BPR5ES-13	
RN12YCC	BPR5ES	BPR5EIX
RN13L	ZGR5C	
RN13LYC	ZGR5C	
RN14LY	ZGR5C	
RN14MC5	BPR4EY-11	
RN14MPMP5	GR4	GR4IX
RN14Y	BPR5ES	BPR5EIX
RN14Y6	BPR5ES-13	
RN14YC	GR4	GR4IX
RN16Y	BPR4ES	
RN16YC5	BPR4ES-13	
RN180B	BR7EM	
RN1C	BR10ES	BR10EIX
RN2	BR9ES	BR9EIX
RN2C	BR9ES	BR9EIX
RN2G	BR9EVX	BR9EIX
RN3	BR8ES	BR8EIX
RN3C	BR8ES	BR8EIX
RN3G	BR8EVX	BR8EIX
RN4	BR7ES	
RN49G		
RN4C	BR7ES	
RN5	BR6ES	
RN57YC	BR10EG	
RN5C	BR6ES	
RN6	BR6ES	
RN6Y	BPR8ES	
RN6YC	BPR8ES	
RN74C	BR6EB-11	
RN79G		
RN7GY	BPR7EVX	BPR7EIX
RN7Y	BPR7ES	BPR7EIX
RN7YC	BPR7ES	BPR7EIX
RN7YCC	BPR7ES	BPR7EIX
RN7YCC4	BPR7ES-11	
RN8	BR5ES	
RN8L	ZGR5C	
RN8VTYC4	BUR6ET	PGR6D

CHAMPION	NGK	Bic*/IX
RN9GY	BPR6EVX	BPR6EIX
RN9LCC		
RN9LCC	ZGR5B	
RN9Y	BPR6ES	BPR6EIX
RN9YC	BPR6ES	BPR6EIX
RN9YC	GR5	
RN9YC4	BPR6ES-11	BPR6EIX-11
RN9YCC	BPR6ES	BPR6EIX
RN9YCC	GR5	
RP10HC	DR5HS	
RP7	DR8HS	
RS10LC	TR5-1	TR5-1IX
RS12YC	BPR5EFS	
RS12YC	TR4	
RS12YC6	BPR5EFS-13	
RS13LYC	TR4-2	
RS14LC	TR5-1	TR5-1IX
RS14LYC	TR4-2	
RS14YC	BPR5EFS	
RS15LYC	TR4-2	
RS17YX	TR4	TR4IX
RS5C	BR7EFS	
RS7YC	BPR7EFS	
RS9YC	BPR6EFS	
RS9YCC	BPR6EFS	
RV12C	BR5FS	
RV12C6	BR5FS-15	
RV12YC	BPR5FS	
RV12YC	UR5	UR5IX
RV12YC6	BPR5FS-15	
RV15YC	BPR4FS	
RV15YC4	UR4	UR4IX
RV15YC4	BPR4FS-11	
RV15YC6	BPR4FS-15	
RV17YC	BPR4FS	
RV17YC6	BPR4FS-15	
RV8C	BR6FS	
RV8C6	BR6FS-15	
RV91MC	BR6FS	
RV92YC	BPR5FS	
RV9YC	UR6	
RV9YC	BPR6FS	
RZ7C	CMR7H	
RZN12Y	BPR5EFS	
RZN12Y5	BPR5EFS	
S10YCC	BP5EFS	
S12YC	BP5EFS	
S279YC	BP6EFS	
S281YC	BP6EFS	
S379YC	BP7EFS	
S59C	R5724-9	
S6YC	BP7EFS	
S7YC	BP7EFS	

CHAMPION	NGK	Bic*/IX
S7YCC	BP7EFS	
S9YC	BP6EFS	
S9YCC	BP6EFS	
UD16	A6	
UJ12	B2	
UJ2J	B8S	
UJ4J	B7S	
UJ6	B6S	
UJ8	B6S	
UJ81C	B7S	
UJ81J	B7S	
UK10	A6	
UL17V	BUHXW-1	
UL18V	BUHX	
UL4J	B7HS	BR7HIX
UL77V	BUHXW-1	
UL81C	B7HS	BR7HIX
UL81J	B7HS	BR7HIX
UN19V	BUE	
UN79Y	BP6ES	BPR6EIX
UY6		
V12YC	BP5FS	
V4C	B7FS	
V63C	R5673-7	
V9YC	BP6FS	
W16Y		
XC12PEPB	PZFR6H	
XJ10Y	BP6S	
YB2	CM6	
Z10	C6HSA	CR6HIX
Z10G	C7HVX	CR7HIX
Z12	C6HSA	CR6HIX
Z6	C8HSA	CR8HIX
Z7G	C7HVX	CR7HIX
Z8	C7HSA	CR7HIX
Z9Y	C7HSA	CR7HIX

Bougies DENSO - NGK

VERGELIJKINGEN/ COMPARAISONS

DENSO	NGK	Bic*/IX	DENSO	NGK	Bic*/IX
9807B-5615P	ZFR6K-11		KJ22CRL8	ZFR7F	
9807B-5615W	IZFR6K-11		L14-U	A6	
J16AR-U11	BRE527Y-11		M17	A6	
J16A-U11	BE527Y-11		M22	A7	
J16AY	BP5EJ		M24S	A8	
J16AYR	BPR5EJ		MA14P-U	AP5FS	
J16BR-U	BRE529Y		MA16PR-U	APR5FS	
J16B-U11	BE529Y-11		MA16PR-U15	APR5FS	
J16CRU	ZGR5A		MA16P-U	AP5FS	
K14PRU-11	BKR4E-11		MA17P-U	AP6FS	
K14P-U11	BKR5E-11	BKR5EIX-11	MA20PR-U	APR6FS	
K16PRP11	BKR5EVX		MA20P-U	AP6FS	
K16PR-U	BKR5E	BKR5EIX	MA20R-U	AR6FS	
K16PR-U11	BKR5E-11	BKR5EIX-11	MA20R-U11	AR6FS	
K16R-U	BKR5EYA		MA9P-U	AP4FS	
K16R-U11	BKR5EYA-11		P16R	BPR5EP-11	
K16TNR69	BKR5EKC		P16R-13	BPR5EP-13	
K16TR-11	BKR5EKB-11		P20PR11	PGR6A-11	
K20DTR-S11	ZFR6G		P20R8	BPR6EP-8	
K20HR-U11	LFR6C-11		PK16PR11	PFR5B-11	
K20PBR-S10	BKUR6ET-10	PFR6Q	PK16PR-P11	PFR5J-11	
K20PR-L11	BKR6EN-11		PK16R11	BKR5EP-11	
K20PR-TP11	BKR6EVX-11		PK16R-8	BKR5EP-8	
K20PR-U	BKR6E	BKR6EIX	PK16TR11	BKR5EKP-11	
K20PR-U11	BKR6E-11	BKR6EIX-11	PK20GR8	BKR6EPA-8	
K20P-U	BK6E		PK20PR11	PFR6B-11	
K20P-U11	BK6E-11		PK20PR-L11	PFR6G-11	
K20R-U	BKR6EYA		PK20PR-P	PFR6J	
K20R-U11	BKR6EY-11	BKR6EIX-11	PK20PR-P11	PFR6J-11	
K20TMR11	BKR6EKC-N-11		PK20PR-TP	PFR6M	
K20TNR-S	BKUR6EK		PK20R11	BKR6EP-11	
K20TR-11	BKR6EKB-11		PK20R-13	PFR6G-13	
K20TRX	BKR6EKU		PK20R-13	BKR6EP-13	
K22PB	BCP7ET	BCP7EVX	PK20R8	BKR6EP-8	
K22PR-L11	BKR7EN-11		PK20R-P8	BKR6EP-N-8	
K22PR-U	BKR7E	BKR7EIX	PK20TR11	BKR6EKP-11	
K22PR-U11	BKR7E-11	BKR7EIX-11	PK22PR11	PFR7B-11	
K22P-U11	BK7E-11		PK22PR-L11	PZFR6F-11	
K22TM11	BK7EK-N-11		PK22PR-L11	PFR7G-11	
K22TMR	BKR7EKC-N		PK22PR-L11	PFR7G-11	
K22TMR11	BKUR7EK		PK22PR-TP	PFR7M	
K29A-Z	R7117-10		PKJ16CR8	PZFR5F	
KJ16CR-L11	ZFR5F-11/ZFR5J-11	ZFR5FIX-11	PKJ16CR-L11	PZFR5F-11	
KJ16CR-L11	ZFR5J-11		PKJ20CR8	PZFR6F	
KJ206CR-L11	ZFR6F-11	ZFR6FIX-11	PKJ20CR-L11	PZFR6F-11	
KJ20CR-L11	ZFR6F-11/ZFR6J-11	ZFR6FIX-11	PQ16R	BCPR5EP-11	
KJ20DR-M11	ZFR6K-11		PQ16R13	BCPR5EP-13	
KJ22CR-L11	ZFR7F-11/ZFR7J-11		PQ16R8	BCPR5EP-8	

DENSO	NGK	Bic*/IX	DENSO	NGK	Bic*/IX
PQ20R	BCPR6EP-11		T16R-U15	BR5FS-15	
PQ20R13	BCPR6EP-13		T20EPR-U	BPR6EFS	
PQ20R8	BCPR6EP-8		T20EP-U	BP6EFS	
PQ20R-P11	BCPR6EP-N-11		T20EX-U	BP6EFS	
PQ20R-P8	BCPR6EP-N-8		T20MP-U	BPM6F	
Pq20RP-8	BCPR6EPN-8		T20M-U	BM6F	
PT16EPRL13	PTR5D-10		T20PR-U	BPR6FS	
PT16VR-13	PTR5A-13		T20PR-U11	BPR6FS-11	
Q14R-U11	BCPR4EY-11		T20PR-U15	BPR6FS	
Q16PR-U	BCPR5E		T20P-U	BP6FS	
Q16PR-U11	BCPR5EY-11	BCPR5EIX-11	T20R-U	BR6FS	
Q16P-U11	BCP5EY-11	BCPR5EIX-11	T22EP-U	BP7EFS	
Q16RU	BCPR5EY	BCPR5EIX-11	T22MP-U	BPM7F	
Q16RU-11	BCPR5EY-11	BCPR5EIX-11	T22M-U	BM7F	
Q16-U	BCP5EY	BCPR5EIX-11	TR20	B6HS	BR6HIX
Q20PR-P11	BCPR6EVX-11		TR22	B7HS	BR7HIX
Q20PR-U	BKR6E	BKR6EIX	TR22-10	B7HS-10	
Q20PR-U11	BCPR6EY-11		TR24	B8HS	BR8HIX
Q20P-U	BCP6ES	BCPR6EIX-11	TR24-10	B8HS-10	
Q20P-U11	BCP6E-11	BCPR6EIX-11	U14FSRUB	CR4HSB	
Q20R-U	BCPR6EY		U16FS-L	C5HSA	CR5HIX
Q20R-U11	BCPR6EY-11		U16FSR-L	CR5HSA	CR5HIX
Q22PR-U	BCPR7ES	BCPR7EIX	U16FSR-U	CR5HSA	CR5HIX
Q22PR-U11	BCPR7ES-11	BCPR7EIX-11	U16FSR-UB	CR5HSB	CR5HIX
Q22P-U	BCP7ES	BCPR7EIX	U16FS-U	C5HSA	CR5HIX
Q22P-U11	BCP7ES-11	BCPR7EIX-11	U16FS-UB	C5HSB	CR5HIX
Q27A-Z	R7232-9		U17F	C5HSA	CR5HIX
QJ16AR-U	BCRE527Y		U16FS-UB	C5HSB	CR5HIX
QJ20CR-11	ZFR6A-11		U17F	C5HSA	CR5HIX
S27	SD9A		U20FS	C6HSA	CR6HIX
S29	SD10A		U20FS-L	C6HSA	CR6HIX
S29A	SD10A		U20FSR-U	CR6HSA	CR6HIX
SD29A	SD10A		U20FS-U	C6HSA	CR6HIX
SF-10	BUHX		U20M-U	CM6	
SF-50	BUHW		U22ESR-N	CR7E	CR7EIX
SF-51	BUHW-2		U22FS	C7HSA	CR7HIX
SK16PR-E11	IFR5E-11/BKR5EIX-11P		U22FS-GU	C7HVX	CR7HIX
SK16PR-L11	IFR5G-11K		U22FS-L	C7HSA	CR7HIX
SK16RP8	IFR5T-8N		U22FSR-L	CR7HS	CR7HIX
SK20BR11	IFR6A-11T		U22FS-U	C7HSA	CR7HIX
SK20R-11	IFR6T-11		U24ES-N	C8E	CR8EIX
SK20R-11	IFR6A11		U24ESR-N	CR8E	CR8EIX
SK22PR-M11	IFR7G-11K		U24ETR	CR8EK	
SKJ20DRM11	IZFR6K-11		U24FE9	C8EH-9	CR8EHIX-9
SKJ20DR-M11	IZFR6K-11		U24FER9	CR8EH-9	CR8EHIX-9
SVK20R-Z8	BKR6EP-8		U24FS	C8HSA	CR8HIX
T14PR-U	BPR4FS		U24FS-C	L8A	
T14PR-U15	BPR4FS-15		U24FS-L	C8HSA	CR8HIX
T16EPR-U	BPR5EFS		U24FSR-C	LR8A	
T16EX-U	BP5EFS		U24FSR-U	CR8HS	CR8HIX
T16PR-U	BPR5FS		U24FS-U	C8HSA	CR8HIX
T16PR-U11	BPR5FS-11		U27ES-N	C9E	CR9EIX
T16PR-U15	BPR5FS-15		U27ESR-N	CR9E	CR9EIX
T16P-U	BP5FS		U27ETR	CR9EK	
T16R-U	BR5FS		U27FE9	C9EH-9	CR9EHIX-9

DENSO	NGK	Bic*/IX
U27FER-9	CR9EH-9	CR9EHIX-9
U31ESR-N	CR10E	
U31ETR	CR10EK	
VUH27D	IMR9C-9H	
W14	B4	
W14E	B4ES	
W14EPR-U	BPR4ES	
W14EP-U	BP4ES	
W14EXR-U	BPR5EA	
W14EXR-U	BPR4EY	
W14EXR-U11	BPR4EY-11	
W14EX-U	BP4EY	
W14EX-U11	BP4EY-11	
W14F	B4H	
W14FP	BP4H	
W14FP-L	BP4HS	
W14FPR	BPR4H	
W14FPR-L	BPR4HS	
W14FPR-UL	BPR4HS	
W14FPR-UL10	BPR4HS-10	
W14FP-U	BP4H	
W14FP-UL	BP4HS	
W14FP-UL10	BP4HS-10	
W14FR-U	BR4HS	
W14F-U	B4H	
W14F-U10	B4H-10	
W14L	B4L	
W14LMR-US	BR4LM	
W14LM-U	B4LM	
W14LM-US	B4LM	
W14MPR-U10	BPRM4A	
W14MP-U10	BPM4A-10	
W14MR-U	BMR4A	
W14M-U	BM4A	
W14M-US	BM4A	
W14P	BP5S	
W14PR-U	BP4	
W14-U	B4	
W14-US	B4	
W16EKR-S11	BUR5EB-11	
W16EK-S11	BUR5EB-11/BU5EB-11	
W16EP-GU	BP5EVX	BPR5EIX
W16EPR-S11	BUR5EA-11	
W16EPR-U	BPR5ES	BPR5EIX
W16EPR-U11	BPR5ES-11	BPR5EIX-11
W16EPU	BP5ES	BPR5EIX
W16EP-U	BP5ES	BPR5EIX
W16EP-U10	BP5ES-11	BPR5EIX-11
W16EP-ZU	BP5EVX	BPR5EIX
W16ES	B5ES	
W16ES-L	BR5ES/BR5EB	
W16ES-L11	BUR5EB-11/BR5EB-11	
W16ESR-U	BR5ES	
W16ES-U	B5ES	
W16ETR-S	BPR5EKA	

DENSO	NGK	Bic*/IX
W16ET-S	BP5EKA	
W16EXR-U	BPR5EY	BPR5EIX
W16EXR-U11	BPR5EY-11	BPR5EIX-11
W16EXU	BP5EY	BPR5EIX
W16EX-U	BP5EAL	
W16EX-U11	BP5EA-L-11	
W16EX-U13	BP5ES-13	
W16FP	BP5HS	
W16FP-L	BP5HA	
W16FPR	BPR5HS	
W16FPR-U	BPR5HS	
W16FP-U	BP5HS	
W16FP-U10	BP5HS-10	
W16FP-UL	BP5HA	
W16FS	B5HS	
W16FSR	BR5HS	
W16FS-U	B5HS	
W16LS	B6L	
W16PR-U	BPR5S	
W16P-U	BP5S	
W17P	BP6S	
W17PR-U	BP6S	
W20DTR-S	BKR6EKB	
W20DTR-SA	BPR6EKB-L	
W20EA	B6EM	
W20EAR	BR6EM	
W20EKR-S11	BUR6EB-11	
W20EK-S11	BUR6EB-11/BU6EB-11	
W20EP	B6ES	
W20EPB	BP6ET	PGR6D
W20EPBRS	BUR6ET	PGR6D
W20EP-GU	BP6EVX	BPR6EIX
W20EPRS-11	BUR6EA-11	
W20EPR-U	BPR6ES	BPR6EIX
W20EPR-U10	BPR6ES-11	BPR6EIX-11
W20EPR-U11	BPR6ES-11	BPR6EIX-11
W20EP-S11	BU6EA-11	
W20EP-U	BP6ES	BPR6EIX
W20EP-U11	BP6ES-11	BPR6EIX-11
W20EP-ZU	BP6EVX	BPR6EIX
W20ES	B6ES	
W20ES-GU	B6EVX	
W20ES-L	BR6ES/B6EB	
W20ES-L11	BUR6EB-11/BU6EB-11	
W20ESR	BR6ES	
W20ESR-L	BR6ES/BR6EB	
W20ESR-L11	BUR6EB-11/BR6EB-11	
W20ES-U	B6ES	
W20ES-U11	B6ES-11	
W20ES-ZU	B6EVX	
W20ET	BP6EK	
W20ET-L	BP6EKN	
W20ETR-L	BPR6EKN	
W20ETR-S	BPR6EK-A	
W20ET-S	BP6EK-A	

DENSO	NGK	Bic*/IX
W20EXR-U	BPR6EY	BPR6EIX
W20EXR-U11	BPR6EY-11	BPR6EIX-11
W20EX-U	BP6EY	
W20EX-U11	BP6EY-11	
W20EX-U13	BP6ES-13	
W20FP	BP6HS	BPR6HIX
W20FP-L	BP6HSA	BPR6HIX
W20FPR	BPR6HS	BPR6HIX
W20FPR-U	BPR6HS	BPR6HIX
W20FP-U	BP6HS	BPR6HIX
W20FP-U10	BP6HS-10	
W20FS	B6HS	BR6HIX
W20FS-GU	B6HVX	BR6HIX
W20FSR	BR6HS	BR6HIX
W20FSR-U	BR6HS	BR6HIX
W20FS-U	B6HS	BR6HIX
W20FS-ZU	B6HVX	BR6HIX
W20M	BM6A	
W20MP-U	BPM6A	
W20MP-U10	BPM6A-10	
W20MR-U	BMR6A	
W20M-U	BM6A	
W20M-US	BM6A	
W20S	B6S	
W20SR-U	BR6S	
W20S-U	B6S	
W21ES-L11	BR6EB-L-11/B6EB-L-11	
W21ESR-L11	BR6EB-L-11	
W22EA	B7EM	
W22EAR	BR7EM	
W22EB	BR7ET/B7ET	
W22EBR	BR7ET	
W22EDR	BR7EQ	
W22EDR14	BR7EQ-14	
W22EK-S11	BUR7EB-11/BU7EB-11	
W22EP	BP7ES	BPR7EIX
W22EP11	BP7ES-11	
W22EP-GU	BP7EVX	BPR7EIX
W22EPR-U	BPR7ES	BPR7EIX
W22EP-S11	BU7EA-11	
W22EP-U	BP7ES	BPR7EIX
W22EP-ZU	BP7EVX	BPR7EIX
W22ES	B7ES	
W22ES-GU	B7EVX	
W22ES-L	B7EB	
W22ES-L11	B7EB-11	
W22ESR	BR7ES	
W22ESR-L	BR7EB	
W22ESR-L11	BR7EB-11	
W22ESR-U	BR7ES	
W22ES-U	B7ES	
W22ES-U11	B7ES-11	
W22ES-ZU	B7EVX	
W22FP	BP7HS	BPR7HIX
W22FPR-U	BPR7HS	BPR7HIX

DENSO	NGK	Bic*/IX
W22FP-U	BP7HS	BPR7HIX
W22FP-U10	BP7HS-10	
W22FS	B7HS	BR7HIX
W22FS-GU	B7HVX	BR7HIX
W22FSR	BR7HS	BR7HIX
W22M	BM7A	
W22MP-U	BPM7A	
W22MP-US	BPM7A	
W22M-U	BM7A	
W22M-US	BM7A	
W22S	B7S	
W22S-U	B7S	
W24EP	BP8ES	
W24EP-11	BP8ES	
W24EP-U	BP8ES	
W24ES	B8ES	BR8EIX
W24ES-GU	B8EVX	BR8EIX
W24ESR	BR8ES	BR8EIX
W24ESR-U	BR8ES	BR8EIX
W24ES-U	B8ES	BR8EIX
W24ES-U11	B8ES-11	
W24ES-V	B8EG	
W24ES-ZU	B8EGV	
W24FP-L	BP8HSA	BPR8HIX
W24FP-U	BP8HS	BPR8HIX
W24FS	B8HS	BR8HIX
W24FS-GU	B8HVX	BR8HIX
W24FSR	BR8HS	BR8HIX
W24FS-U	B8HS	BR8HIX
W24FS-U10	B8HS-10	
W24FS-ZU	B8HVX	BR8HIX
W24S	B8S	
W24S-U	B8S	
W25EA	B8EM	
W25EAR	BR8EM	
W25EB	BR8ET/B8ET	
W25EBR	BR8ET	
W25EDR	BR8EQ	
W25EDR14	BR8EQ-14	
W25EN	B8EG	
W25EPT	B8EGP	
W25FC	B8HCS	
W25FN	B8HVX	BR8HIX
W27EBR	BR9ET	
W27EDR14	BR9EQ-14	
W27EMR-C	BR9ECM	
W27EN	B9EG	
W27EPT	B9EGP	
W27ES	B9ES	BR9EIX
W27ES-GU	B9EVX	BR9EIX
W27ESR	BR9ES	BR9EIX
W27ES-U	B9ES	BR9EIX
W27ES-V	B9EG	
W27ES-ZU	B9EGV	
W27FC	B9HCS	

DENSO	NGK	Bic*/IX
W27FS	B9HS	
W27FS-GU	B9HVX	
W27FSR	BR9HS	
W27FS	B9HS	
W27FS-U10	B9HS-10	
W27FS-ZU	B9HVX	
W27S	B9S	
W27S	B9S	
W29EPT	B95EGP	
W29ES-GU	B95EGV	
W29ES-ZU	B95EGV	
W31EN	B10EG	
W31EPT	B10EGP	
W31ES	B10ES	BR10EIX
W31ES-GU	B10EVX	BR10EIX
W31ES-U	B10ES	BR10EIX
W31ES-ZU	B10EGV	
W31FS	B10HS	BR10HIX
W31FS-GU	B10HVX	BR10HIX
W31FS-ZU	B10HVX	BR10HIX
W32EPT	B105EGP	
W34ES-ZU	B11EGV	
W9	B2	
W9EP	BP2E	
W9EXR-U	BPR2ES	
W9EX-U	BP2E	
W9FP	BP2H	
W9FP-L	BP2HS	
W9FP-UL	BP2HS	
W9LMR-US	BR2LM	
W9LM-US	B2LM	
W9P	BP4	
W9-U	B2	
WA20M	BM6F	
WA20M-U	BM6F	
WA22M	BM7F	
WA22M-U	BM7F	
X16FSR-U	DR5HS	
X20EPR-GL	PJR6A	
X20FS-GU	D6HVX	
X20FSR-U	DR6HS	
X20FS-U	D6HA	
X22EPR-GL	PJR7A	
X22EPR-U9	DPR7EA-9	DPR7EIX-9
X22EP-U9	DP7EA-9	DPR7EIX-9
X22ES-GU	D7EVX	
X22ESR-U	DR7ES	
X22ES-U	D7EA	
X24EPR-GL	PJR8A	
X24EPR-U9	DPR8EA-9	DPR8EIX-9
X24EP-U9	DP8EA-9	DPR8EIX-9
X24ES-GU	D8EVX	DR8EIX
X24ESR-U	DR8ESL	DR8EIX

DENSO	NGK	Bic*/IX
X24ES-U	D8EA	DR8EIX
X24FSR-U	DR8HS	
X24FS-U	D8HA	
X24GPR-U	DPR8Z	
X24GP-U	DP8Z	
X27EPR-U9	DPR9EA-9	DPR9EIX-9
X27EP-U9	DP9EA-9	DPR9EIX-9
X27ESR-U	DR8ES	DR8EIX
X27ES-U	D9EA	DR9EIX
X27GPR-U	DPR9Z	
X27GP-U	DP9Z	
X31ES-U	D10EA	
XE20HRU9	LZKAR7A	
XU20EPR-U	DCPR6E	
XU20EP-U	DCP6E	
XU22EPR-U	DCPR7E	DCPR7EIX
XU22EPR-ZU	DCPR7EVX	DCPR7EIX
XU22EP-U	DCP7E	
XU22EP-ZU	DCP7EVX	
XU24EPR-U	DCPR8E	DCPR8EIX
XU24EPR-ZU	DCPR8EVX	DCPR8EIX
XU24EP-U	DCP8E	
XU24EP-ZU	DCP8EVX	
Y27FER	ER9EH	
Z20ES-U	D6EA	

SYMBOLES D'IDENTIFICATION DES BOUGIES

Dimension du filetage/ Dimension du Hex

- A: 18 mm / 1 po (25.4 mm)
- B: 14 mm / 13/16 po (20.8 mm)
- C: 10 mm / 5/8 po (16.0 mm)
- D: 12 mm / 5/8 po (18.0 mm)
- E: 8 mm / 13.0 mm
- J: 12 mm / 5/8 po (18.0 mm)
- AB: 18 mm / 13/16 po (20.8 mm)
- BC: 14 mm / 5/8 po (16.0 mm)
Type JIS
- BK: 14 mm / 5/8 po (16.0 mm)
Type ISO
- DC: 12 mm / 5/8 po (16.0 mm)

Construction

(Plus d'une lettre peut être utilisée)

- K: Clé 5/8 po proéminent (ISO)
- L: Type compact (court)
- M: Type compact
- P: Type à isolant proéminent
- R: Type à résistance
- U: Modèle à électrodes de niveau ou semi-niveau
- Z: Résistance à induction

Longueur de filetage

- E: 19 mm (3/4 po)
- EF: Siège conique
17.5 mm (Portée .708 po)
- FS: Siège conique
10.9 mm (.460 po)
- H: 12.07 mm (1/2 po)
- EH: Demi-filetage
19 mm (Portée totale 3/4 po)
12.7 mm (Portée totale 1/2 po)
- L: 11.2 mm (7/16 po)
- S: Portée 9,5 mm (3/8 po)
- Z: 21 mm

Sans symbole :

18mmø = Portée 12 mm

14mmø = Portée 9.5 mm (3/8 po)

Longueur de filetage

- A: Mode spéciale
- B: Mode spéciale
- C: Électrodes à la masse à angle réduit
- CM: Type compact, électrodes à la masse à angle réduit
- E: Type électrode centrale à rainure en V (14 mm seulement) 1/5 mm isolant
- ES: Portée de filetage standard 3/4 po (2.5mm) électrode centrale
- F: Siège conique
- G: Électrodes au centre de alloy au nickel avec fils fine
- G-G: Pour course
- GP: Pour course platine laser (0.6mmø)
- GV: Électrode central à rainure en V, spéciale (pour course)
- IX: Iridium à haute performance
- K: Deux électrodes à la masse
- L: Demi-gamme de chaleur (voir le diagramme)
- LM: Type compact pour tondeuses à gazon
- M: Deux électrodes à la masse pour moteurs rotatifs Mazda
- N: Électrode latérale spéciale
- P: Platine premium
- Q: Quatre électrodes à la masse
- R: Électrode de masse spéciale
- S: Électrode centrale de 2.5mmø
- T: Trois électrode à la masse
- U: Décharge à semi-niveau
- V: Type à électrode à noyau en métal précieux (Palladium en or)
- VX: Platine de haute performance
- W: Électrodes tungstène
- X: Écart de survolteur
- Y: Type électrode centrale à rainure en V (14mm) 2.5mmø isolant
- Z: Épaisse électrode centrale de 2.9mmø

B C P R 6 E S - 11

Types à écartement d'électrode élargie

- 8** 0.8 mm (.032 po)
- 9** 0.9 mm (.036 po)
- 10** 1.0 mm (.039 po)
- 11** 1.1 mm (.044 po)
- 13** 1.3 mm (.052 po)
- 14** 1.4 mm (.055 po)
- 15** 1.5 mm (.059 po)
- 20** 2.0 mm (.080 po)

Type de bougie

- I: Platine iridium
- IZ: Électrodes Iridium et écartement prolongé
- L: Longueur du filetage 26.5 mm
- P: Platine premium
- PL: Électrodes au platine et longueur de filetage 26.5 mm
- PZ: Électrodes au platine et écartement prolongé
- Z: Écartement élargi

Degré Thermique

2 Chaud

12 Froid

Construction du bec d'allumage

- A,B,C...: Concept spéciale
- J: Concept spéciale

P F R 6 A - 11 A

Dimensions de caisse métallique

- F: Portée ø 14, 19 mm (3/4 po), clé 16 mm (5/8 po)
- G: Portée ø 14, 19 mm (3/4 po), clé 20.6 mm (13/16 po)
- J: Portée ø 12, 19 mm (3/4 po), clé 19 mm
- M: Portée ø 10, 19 mm (3/4 po), clé 16 mm (5/8 po)
- T: Siège conique ø 14, 17.5 mm, clé 16 mm (5/8 po)
- PTR5A-13: Portée ø 14, 25 mm, clé 16 mm (5/8 po)

Construction

- R: Résistance

Caractéristiques

- A: Pas de joint
- B: Concept spéciale
- C: Concept spéciale
- D: Concept spéciale

Symboles utilisés pour les bougies

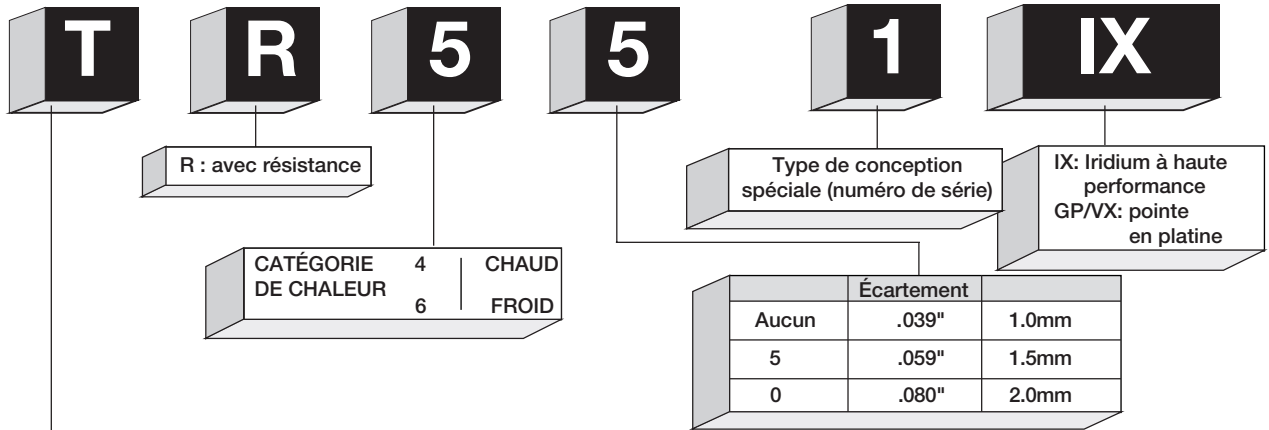

Lettre	Diamètre du filetage	Portée	Type d'isolant	Type de siège
F	14mm Hex. 5/8"	3/4" (19mm)	Projeté	avec joint
F-1	14mm Hex. 5/8"	(22mm)	Projeté	avec joint
G	14mm	3/4" (19mm)	Projeté	avec joint
T	14mm Hex. 5/8"	.708"	Projeté	siège effilé
T-1	14mm Hex. 5/8"	.807"	Projeté	siège effilé
U	14mm	.460"	Projeté	siège effilé
W	18mm	.460"	Projeté	siège effilé
X	14mm	3/8"	Projeté	avec joint
Y	14mm	.460"	Non-projeté	siège effilé

CATÉGORIE DE CHALEUR
Chaud = 4
Froid = 7

Écartement de la bougie	
Aucun	= .032" (0.8mm)
-11	= .044" (1.1mm)

Préfixe	Construction du corp	Diamètre du filetage	Type d'isolant	Type de bougie	Portée	Suffixe	Construction du siège
BCPR	5/8" Hex	14mm	Projeté	Résistance	3/4"	E, EY, EYA	Siège avec joint
BKR	5/8" Hex (ISO)	14mm	Projeté	Résistance	3/4"	E, EY, EYA	Siège avec joint
BR	5/8" Hex (ISO)	14mm	Non-Projeté	Résistance	3/4"	EF	Siège effilé
BR	13/16" Hex	14mm	Non-Projeté	Résistance	3/4"	EYA	Siège avec joint
BPM (Type compact)	3/4" Hex	14mm	Projeté	Non-Résistance	3/8"	Y	Siège avec joint
BPMR (Type compact)	3/4" Hex	14mm	Projeté	Résistance	3/8"	Y	Siège avec joint
BP	13/16" Hex	14mm	Projeté	Non-Résistance	3/4"	EY	Siège avec joint
BPR	13/16" Hex	14mm	Projeté	Résistance	3/4"	EY	Siège avec joint
BP	13/16" Hex	14mm	Projeté	Non-Résistance	1/2"	HN	Siège avec joint
B	13/16" Hex	14mm	Non-Projeté	Non-Résistance	3/8"	Y	Siège avec joint
BMR (Type compact)	3/4" Hex	14mm	Non-Projeté	Résistance	3/8"	Y	Siège avec joint
BM (Type compact)	3/4" Hex	14mm	Non-Projeté	Non-Résistance	3/8"	Y	Siège avec joint

Type d'écartement prolongé

Préfixe	Construction du corp	Diamètre du filetage	Type d'isolant	Type de bougie	Portée	Suffixe	Construction du siège
ZGR	13/16" Hex	14mm	Projeté	Résistance	3/4"	A	Siège avec joint
ZGR	13/16" Hex	14mm	Projeté	Résistance	22.0mm	C	Siège avec joint
ZFR	5/8" Hex (ISO)	14mm	Projeté	Résistance	22.5mm	E	Siège avec joint
ZFR	5/8" Hex (ISO)	14mm	Projeté	Résistance	3/4"	FJ	Siège avec joint

Thread Diameter	
A:	18 mm
B:	14 mm
C:	10 mm
D:	12 mm
J:	12 mm

Thread Reach	
E:	19 mm (3/4")
EF:	Tapered Seat 17.5 mm (.708" Reach)
FS:	Tapered Seat 10.9 mm (.460")
H:	12.7 mm (1/2")
EH:	Partial thread 19 mm (3/4" Total Reach) 12.7 mm (1/2" Total Thread)
L:	11.2 mm (7/16")
S:	9.5 mm (3/8") Reach
Z:	21 mm
NO SYMBOL:	
	18mmø = 12 mm Reach
	14mmø = 9.5 mm (3/8") Reach

Firing End Construction	
A:	Special Design
B:	Special Design
C:	Low Angle Ground Electrode
CM:	Compact type, low angle ground electrode
E:	V-Grooved center electrode (14mm only) 1.5mm Insulator
ES:	Standard 3/4" Thread Reach (2.5mm) center electrode
F:	Tapered Seat
G:	Fine wire nickel alloy center electrode
G-G:	Copper core ground electrode
GP:	Platinum Firewire (6mm)
GV:	Gold-palladium center electrode Special Construction of V-Type. Racing use
IX:	High Performance Iridium
K:	2-Ground electrodes
L:	Half heat range, (See spec. chart)
LM:	Compact type for Lawn Mower
M:	2-Ground electrodes For Mazda Rotary Eng.
N:	Special Side electrode
P:	Premium Platinum
Q:	4-Ground electrode
R:	Special Ground electrode
S:	Standard 2.5mmø center electrode
T:	3-Ground electrode
U:	Semi-surface discharge
V:	Fine wire gold palladium center electrode
VX:	High performance platinum
W:	Tungsten electrode
X:	Booster gap
Y:	V-Grooved center electrode (14mm only) 2.5mm Insulator
Z:	Thick 2.9mmø center electrode

Construction (ONE OR MORE LETTERS MAY BE COMBINED)	
C:	Hex Size 5/8"
K:	Hex Size 5/8" Projected Tip (ISO)
M:	Compact Type
P:	Projected Insulator Type
R:	Resistor Type
U:	Surface or Semi-Surface Discharge Type
Z:	Inductive Resistor



- WIDE GAP -	
8	0.8mm (.032")
9	0.9mm (.036")
10	1.0mm (.040")
11	1.1mm (.044")
13	1.3mm (.052")
14	1.4mm (.055")
15	1.5mm (.060")
20	2.0mm (.080")

Plug Type	
I:	Iridium Platinum
L:	Thread Reach 26.5mm
P:	Premium Platinum
Z:	Extended Gap

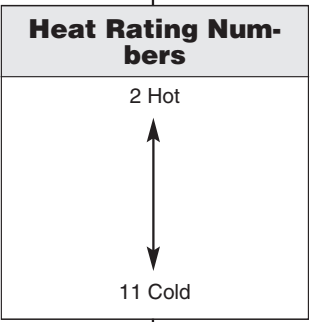

Firing End Construction	
A, B, C, ...:	Special Design



Metal Shell Size	
F:	ø 14, 19mm (3/4") Reach, 16mm (5/8") Hex.
G:	ø 14, 19mm (3/4") Reach, 20.6mm (13/16") Hex.
J:	ø 12, 19mm (3/4") Reach, 19mm Hex.
M:	ø 10, 19mm (3/4") Reach, 16mm (5/8") Hex.
T:	Tapered Seat ø 14, 17.5mm Reach, 16mm (5/8") Hex.
PTR5A-13:	ø 14, 25mm Reach, 16mm (5/8") Hex.

Construction	
R:	Resistor

DESIGN SYMBOLS: SPARK PLUGS

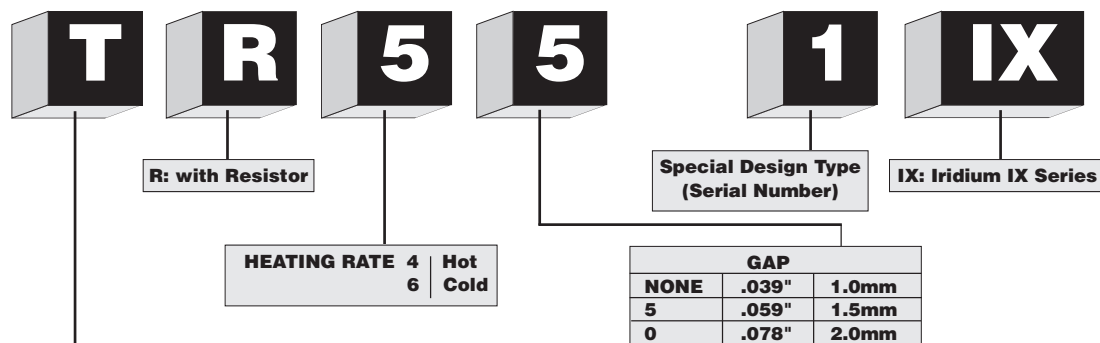

Letter	Thread Diameter	Reach	Insulator Type	Seat Type
F	14 mm Hex. 5/8"	3/4" (19mm)	Projected	Gasket Seat
F-1	14 mm Hex. 5/8"	22mm	Projected	Gasket Seat
G	14 mm	3/4" (19mm)	Projected	Gasket Seat
T	14 mm Hex. 5/8"	.708"	Projected	Taper Seat
T-1	14 mm Hex. 5/8"	.807"	Projected	Taper Seat
U	14 mm	.460"	Projected	Taper Seat
W	18 mm	.460"	Projected	Taper Seat
X	14 mm	3/8"	Projected	Gasket Seat
Y	14 mm	.460"	Non-Projected	Taper Seat

HEAT RATING
Hot = 4
Cold = 7

SPARK PLUG GAP
None = .031 (0.8mm)
-11 = .043 (1.1mm)

Prefix	Hex	Thread Diameter	Insulator Type	Plug Type	Reach	Suffix Type	Seat Type
BCPR	5/8"	14mm	Projected	Resistor	3/4"	E,EY,EYA	Gasket Seat
BKR	5/8" (ISO)	14mm	Non-Projected	Resistor	3/4"	E,EY,EYA	Gasket Seat
BR	5/8"	14mm	Non-Projected	Resistor	3/4"	EF	Tapered Seat
BR	13/16"	14mm	Non-Projected	Resistor	3/4"	EYA	Gasket Seat
BPM (Compact Type)	3/4"	14mm	Projected	Non-Resistor	3/8"	Y	Gasket Seat
BP	13/16"	14mm	Projected	Non-Resistor	3/4"	EY	Gasket Seat
BPR	13/16"	14mm	Projected	Resistor	3/4"	EY	Gasket Seat
BP	13/16"	14mm	Projected	Non-Resistor	1/2"	HN	Gasket Seat
B	13/16"	14mm	Non-Projected	Non-Resistor	3/8"	Y	Gasket Seat
BPMR (Compact Type)	3/4"	14mm	Projected	Resistor	3/8"	Y	Gasket Seat
BM (Compact Type)	3/4"	14mm	Non-Projected	Non-Resistor	3/8"	Y	Gasket Seat
BMR (Compact Type)	3/4"	14mm	Non-Projected	Resistor	3/8"	A	Gasket Seat

EXTENDED GAP TYPE

Prefix	Hex	Thread Diameter	Insulator Type	Plug Type	Reach	Suffix Type	Seat Type
ZGR	13/16"	14mm	Projected	Resistor	3/4"	A	Gasket Seat
ZGR	13/16"	14mm	Projected	Resistor	22.0mm	C	Gasket Seat
ZFR	5/8" (ISO)	14mm	Projected	Resistor	22.5mm	E	Gasket Seat
ZFR	5/8" (ISO)	14mm	Projected	Resistor	3/4"	F,J	Gasket Seat